

CiA 404



Device profile for measuring devices and closed-loop controllers

Version: 1.2.0
15 May 2002

© CAN in Automation (CiA) e. V.

General information on licensing and patents

CAN in AUTOMATION (CiA) calls attention to the possibility that some of the elements of this CiA specification may be subject of patent rights. CiA shall not be responsible for identifying any or all such patent rights.

Because this specification is licensed free of charge, there is no warranty for this specification, to the extent permitted by applicable law. Except when otherwise stated in writing the copyright holder and/or other parties provide this specification “as is” without warranty of any kind, either expressed or implied, including, but not limited to, the implied warranties of merchantability and fitness for a particular purpose. The entire risk as to the correctness and completeness of the specification is with you. Should this specification prove failures, you assume the cost of all necessary servicing, repair or correction.

Trademarks

CANopen® and CiA® are registered community trademarks of CAN in Automation. The use is restricted for CiA members or owners of CANopen vendor ID. More detailed terms for the use are available from CiA.

© CiA 2002

All rights reserved. Unless otherwise specified, no part of this publication may be reproduced or utilized in any form or by any means, electronic or mechanical, including photocopying and microfilm, without permission in writing from CiA at the address below.

CAN in Automation e. V.
Kontumazgarten 3
DE - 90429 Nuremberg, Germany
Tel.: +49-911-928819-0
Fax: +49-911-928819-79
Url: www.can-cia.org
Email: headquarters@can-cia.org

CONTENTS

1	SCOPE	9
2	REFERENCES.....	10
3	DEFINITIONS AND ABBREVIATIONS	11
4	OPERATING PRINCIPLE	12
4.1	Introduction	12
4.2	General object dictionary layout	13
4.2.1	Digital input function block.....	15
4.2.2	Analogue input function block	15
4.2.3	Digital output function block	16
4.2.4	Analogue output function block.....	17
4.2.5	Controller function block	18
4.2.6	Alarm function block	19
4.2.7	Device function block.....	19
5	ERROR HANDLING	20
5.1	Principle.....	20
5.2	Error behaviour	20
5.3	Error code meanings	20
5.4	Additional error codes	21
6	PRE-DEFINITIONS.....	22
6.1	Principle.....	22
6.2	Naming conventions.....	22
6.3	PDO Mapping	22
6.3.1	Object 1000h: Device type	22
6.3.2	Object 1001h: Error Register	22
6.3.3	Object 1029h: Error Behaviour	23
6.3.4	1st receive PDO parameters (Received Process Values).....	24
6.3.5	1st transmit PDO parameters (Analogue Input)	25
6.3.6	2nd receive PDO parameters (Command Values for Controller).....	25

6.3.7	2nd transmit PDO parameters (Effective Controller Output)	26
6.3.8	3rd receive PDO parameters (alternate received process value)	26
6.3.9	3rd transmit PDO parameters (alarm)	27
6.3.10	4th receive PDO parameters (Digital Output)	27
6.3.11	4th transmit PDO parameters (Digital Input)	28
6.3.12	5th receive PDO parameters (Control Bytes)	28
6.3.13	6th receive PDO parameters (Multiplexor PDO)	29
7	OBJECT DICTIONARY	30
7.1	Survey object dictionary	31
7.1.1	Digital input function block	31
7.1.2	Analogue input function block	31
7.1.3	Digital output function block	33
7.1.4	Analogue output function block	33
7.1.5	Controller function block	34
7.1.6	Alarm function block	36
7.1.7	Device function block	37
7.2	Detailed object specification	38
7.2.1	Object 6000h: DI Read state 8 Input Lines	38
7.2.2	Object 6002h: DI Polarity 8 Input Lines	38
7.2.3	Object 6020h: DI Read state 1 Input Lines	40
7.2.4	Object 6030h: DI Polarity 1 Input Lines	41
7.2.5	Object x100h: AI Input FV	42
7.2.6	Object x103h: AI Interrupt delta input FV	43
7.2.7	Object 6110h: AI Sensor type	43
7.2.8	Object 6111h: AI Autocalibration	45
7.2.9	Object 6112h: AI Operating mode	46
7.2.10	Object 6114h: AI ADC sample rate	47
7.2.11	Object x120h: AI Input scaling 1 FV	48
7.2.12	Object x121h: AI Input scaling 1 PV	49
7.2.13	Object x122h: AI Input scaling 2 FV	50
7.2.14	Object x123h: AI Input scaling 2 PV	51

7.2.15	Object x124h: AI Input offset.....	52
7.2.16	Object 6125h: AI Autozero	53
7.2.17	Object x126h: AI Scaling Factor	54
7.2.18	Object 6127h: AI Scaling Offset.....	55
7.2.19	Object x130h: AI Input PV	56
7.2.20	Object 6131h: AI Physical unit PV	57
7.2.21	Object 6132h: AI Decimal digits PV.....	59
7.2.22	Object x133h: AI Interrupt delta input PV.....	59
7.2.23	Object x134h: AI Interrupt lower limit input PV	60
7.2.24	Object x135h: AI Interrupt upper limit input PV	61
7.2.25	Object x138h: AI Tare zero	62
7.2.26	Object 6139h: AI Autotare	63
7.2.27	Object x140h: AI Net PV	64
7.2.28	Object x143h: AI Interrupt delta net PV.....	65
7.2.29	Object x144h: AI Interrupt lower limit net PV	66
7.2.30	Object x145h: AI Interrupt upper limit net PV	67
7.2.31	Object x148h: AI Span start	68
7.2.32	Object x149h: AI Span end	69
7.2.33	Object 6150h: AI Status	70
7.2.34	Object 6160h: AI Control byte.....	72
7.2.35	Object 6161h: AI Control byte enable	73
7.2.36	Object 61A0h: AI Filter type	74
7.2.37	Object 61A1h: AI Filter constant	75
7.2.38	Object 6200h: DO Write state 8 output lines	76
7.2.39	Object 6202h: DO Polarity 8 output lines.....	77
7.2.40	Object 6206h: DO Fault mode 8 output lines.....	78
7.2.41	Object 6207h: DO Fault state 8 output lines.....	79
7.2.42	Object 6210h: DO Link object 8 output lines	80
7.2.43	Object 6220h: DO Write state 1 output lines	81
7.2.44	Object 6240h: DO Polarity 1 output lines.....	82
7.2.45	Object 6250h: DO Fault mode 1 output lines.....	83

7.2.46	Object 6260h: DO Fault state 1 output lines	84
7.2.47	Object 6280h: DO Link object 1 output lines	85
7.2.48	Object x300h: AO Output PV	86
7.2.49	Object 6301h: AO Physical unit PV	87
7.2.50	Object 6302h: AO Decimal digits PV	88
7.2.51	Object 6303h: AO Link output PV	89
7.2.52	Object 6310h: AO Output type	90
7.2.53	Object x320h: AO Output scaling 1 PV	91
7.2.54	Object x321h: AO Output scaling 1 FV	93
7.2.55	Object x322h: AO Output scaling 2 PV	94
7.2.56	Object x323h: AO Output scaling 2 FV	95
7.2.57	Object x330h: AO Output FV	96
7.2.58	Object 6331h: AO Physical unit FV	97
7.2.59	Object 6332h: AO Decimal digits FV	97
7.2.60	Object 6340h: AO Fault mode	98
7.2.61	Object x341h: AO Fault FV	99
7.2.62	Object x400h: CO Effective Current Value Xeff	101
7.2.63	Object x401h: CO Effective Set Point Weff	102
7.2.64	Object x402h: CO Set point W	103
7.2.65	Object x403h: CO 2nd Set point W2	104
7.2.66	Object x404h: CO Lower Set Point Limit W0	105
7.2.67	Object x405h: CO Upper Set Point Limit W100	106
7.2.68	Object 6406h: CO Physical Unit Current Value / Set Point	107
7.2.69	Object 6407h: CO Decimal Digits Current Value / Set Point	108
7.2.70	Object 6410h: CO Effective Controller Output Y	109
7.2.71	Object 6411h: CO Differential Controller Output Ydiff	110
7.2.72	Object 6412h: CO Manual Controller Output	111
7.2.73	Object 6413h: CO Lower Controller Output Limit Ymin	112
7.2.74	Object 6414h: CO Upper Controller Output Limit Ymax	113
7.2.75	Object 6415h: CO Physical Unit Controller Output	114
7.2.76	Object 6420h: CO Set Point switch W/W2	115

7.2.77	Object 6421h: CO Automatic/Manual Mode switch A/M	116
7.2.78	Object 6422h: CO Controller On/Off	117
7.2.79	Object 6423h: CO Controller mode	118
7.2.80	Object 6424h: CO Self Optimization on/off	119
7.2.81	Object 6425h: CO Control Byte	120
7.2.82	Object 6426h: CO Control byte enable	121
7.2.83	Object 6427h: CO Status Word	122
7.2.84	Object x430h: CO Minimum Pulse Time Tmin1	124
7.2.85	Object x431h: CO Minimum Pulse Time Tmin2	125
7.2.86	Object x432h: CO Motor Response Time Tm.....	126
7.2.87	Object x433h: CO Min. Pulse Length Tpuls.....	127
7.2.88	Object 6434h: CO Physical Unit Pulse Timing	128
7.2.89	Object 6435h: CO Decimal Digits Pulse Timing	129
7.2.90	Object x440h: CO Neutral Zone 3point Xsh1	130
7.2.91	Object x441h: CO Neutral zone 3point Xsh2.....	131
7.2.92	Object x442h: CO Neutral zone 3point stepping Xsh.....	132
7.2.93	Object x443h: CO Switching difference of signaller Xsd1	133
7.2.94	Object x444h: CO Switching difference of additional Contact Xsd2	134
7.2.95	Object x445h: CO Trigger point separation of additional contact LW	135
7.2.96	Object x450h: CO Proportional Band Xp1	136
7.2.97	Object x451h: CO Proportional Band Xp2	137
7.2.98	Object x452h: CO Integral Action Time Tn1	138
7.2.99	Object x453h: CO Integral Action Time Tn2	139
7.2.100	Object x454h: CO Derivate Action Time Tv1.....	140
7.2.101	Object x455h: CO Derivate Action Time Tv2.....	141
7.2.102	Object x456h: CO Cycle Time T1.....	142
7.2.103	Object x457h: CO Cycle Time T2.....	143
7.2.104	Object 6458h: CO Physical Unit PID Timing	144
7.2.105	Object 6459h: CO Decimal Digits PID Timing	145
7.2.106	Object x500h: AL 1 Input value.....	146
7.2.107	Object 6503h: AL 1 Link input.....	147

7.2.108	Object x504h: AL 1 Alternate input value.....	148
7.2.109	Object 6505h: AL 1 Link alternate input.....	149
7.2.110	Object 6506h: AL 1 Fault mode.....	150
7.2.111	Object 6507h: AL 1 Fault state.....	151
7.2.112	Object 6508h: AL 1 Type.....	151
7.2.113	Object 6509h: AL 1 Action.....	153
7.2.114	Object x50Ah: AL 1 Level.....	154
7.2.115	Object x50Bh: AL 1 Hysteresis.....	155
7.2.116	Object 650Ch: AL 1 Group.....	156
7.2.117	Object 650Dh: AL 1 State.....	157
7.2.118	Object 650Eh: AL 1 Reset.....	158
7.2.119	Object 6600h: AL 1..8 State.....	159
7.2.120	Object 6601h: AL 9..16 State.....	160
7.2.121	Object 6602h: AL General state.....	161
7.2.122	Object 6603h: AL Group 1..8 State.....	162
7.2.123	Object 6610h: AL General Reset.....	162
7.2.124	Object 6611h: AL 1..8 Reset.....	162
7.2.125	Object 6612h: AL 9..16 Reset.....	164
7.2.126	Object 6F20h: Life counter.....	165
7.2.127	Object 6F30h: Receive PDO check.....	166
7.2.128	Object 6F31h: Transmit PDO check.....	167
7.2.129	Object xF50h: Received PV.....	168
7.2.130	Object xF51h: Alternate received PV.....	169
7.2.131	Object 6F52h: Received status.....	170
7.2.132	Object 6F53h: Alternate received status.....	171
7.2.133	Object 6F60h: Transmission Enable.....	172

1 SCOPE

This document represents the device profile for measuring devices and for universal controller devices for measuring or controlling physical quantities like temperature or pressure. These devices use communication techniques which are conform to those described in /2/. This document should be consulted in parallel to this profile.

2 REFERENCES

- /1/ ISO 11898, Road vehicles - Interchange of digital information - Controller area network (CAN) for high-speed communication, 1993
- /2/ CiA DS 301 V4.01, CANopen Application Layer and Communication Profile, May 2000
- /3/ CiA DS 401 V2.0, CANopen Device Profile for Generic IO Modules, December 1999
- /4/ CiA DSP 302 V1.0, Framework for Programmable CANopen Devices, April 1998
- /5/ CiA DRP 303-2 V1.0, Representation of SI Units and Prefixes, July 1999

3 DEFINITIONS AND ABBREVIATIONS

CAN

Controller Area Network. Data link layer protocol for serial communication as specified in /1/.

CiA

CAN in Automation international users and manufacturers group e.V. Non-profit association promoting Controller Area Network (CAN).

COB

Communication Object, which is made of one or more CAN frames. Any information transmitted via CANopen has to be mapped into COB's.

COB-ID

COB-Identifier. Identifies a COB uniquely in a CAN network. The identifier determines the priority of that COB in the data link layer, too.

I/O

Input and output

RPDO

Receive Process Data Object. Communication object of a device, which contains output data.

SDO

Service Data Object. Peer-to-peer communication with access to the Object Dictionary of a CANopen device.

TPDO

Transmit Process Data Object. Communication object of a device, which contains input data

4 OPERATING PRINCIPLE

4.1 Introduction

The purpose of this device profile is to describe units for measuring or closed loop control of different physical quantities. As such devices may include quite different functionality, the profile specifies different functional blocks, which could be combined in a real device. Which functional blocks are included is coded within the device type object (1000h)

The purpose of the devices described in this document is to measure or control a physical quantity in a process environment. Often these types of devices are implemented as multiple channel devices.

Once configured via SDO, the device is able to run its measuring or control tasks without necessarily needing further real time communication with host systems. Every device has a large amount of data for configuration purposes. The control loop itself is realised in the controller device. All data of the device has to be accessed via SDO.

In order to reduce busload the device communicates based on events. In general there are three types of events - information, warnings and errors.

- Information - this event is used for indicating that a set-point has been reached, or that an output has been set. Information events may also be used to transfer data (e.g. measuring values) on a cyclical basis For this purpose it is suggested to use the SYNC-message specification of /2/.
- Warning - this event indicates that a warning limit has been reached,
- Error - this event indicates that an error has occurred on the device.

The event-based communication can be established in the following manner.

1. The device indicates the host device in the network that an event has occurred.
2. The host device reads the data from the device via SDO.

4.2 General object dictionary layout

All parameters of the device are accessible via the object dictionary. In order to implement multiple channel devices, parameters are arranged in arrays. Each array has up to `number of channels + 5` entries. The maximum number of available channels is 199.

Index	Sub-Index	Parameter
xxxxh	0h	number of entries
	1h	parameter x for channel 1
	:	:
	C7h	parameter x for channel 199
	C8h	reserved
	:	:
	FEh	reserved
	FFh	data type and object type specified in /2/ (optional)

In order to access a particular parameter via SDO, the parameter must be addressed with the index and the channel has to be addressed with the sub-index. Devices with only one channel use the sub-indices 0h and 1h only.

To improve the readability of the object dictionary, all objects are allied to a function block model. This model collects all objects belonging to a specific function to a function block. These are the

1. Digital input function block
2. Analogue input function block
3. Digital output function block
4. Analogue output function block
5. Controller function block
6. Alarm function block
7. Device function block

The function block Controller is divided into functions such as

- process values
- admissible value ranges
- basic controller parameters
- parameter set

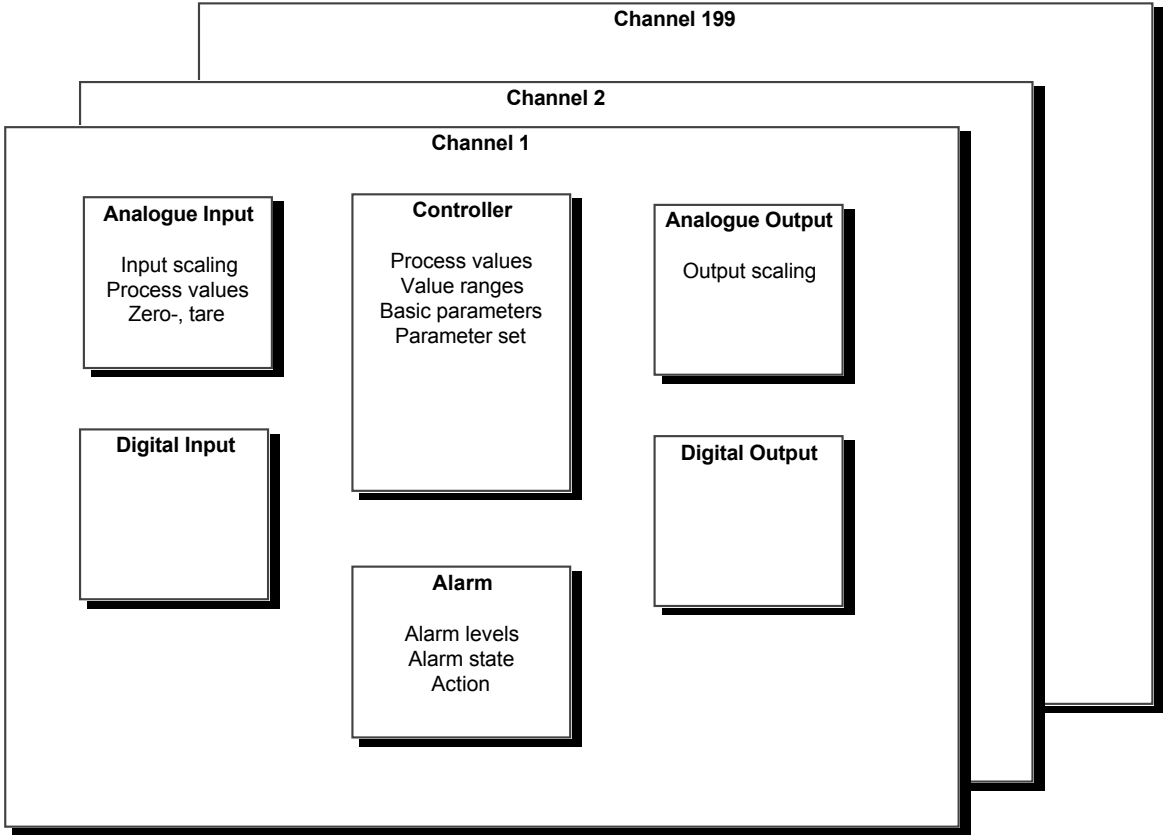

Figure 1: Function block model

4.2.1 Digital input function block

If Module incorporates digital input lines they are addressed according to a subset of the CANopen device profile /3/. Only 1 and 8 Bit access are defined.

4.2.2 Analogue input function block

This functional block may describe the measuring input of a closed loop controller, but may also be used for a sensor with CANopen interface.

The analogue input function block describes how field values are converted to process values.

Examples for **field values** could be:

- unscaled readings from analogue digital converter
- counting readings from incremental encoders
- calibrated electrical value at input terminal of measuring transformer (mA, V, mV/V)

These field values are converted to the real physical dimension of the measured quantity, and the result is called "process value".

Examples for **process values** could be:

- Value in kg for weight measurement
- Value in Centigrade for temperature measurement
- Value in mm for displacement measurement
- Value in Bar for pressure measurement

The conversion from field value to process value is generally described as a linear transformation. This is defined by two pairs of field value and corresponding process value (Input Scaling 1 FV / Input Scaling 1 PV and Input Scaling 2 FV / Input Scaling 2 PV) called calibration point 1 and 2.

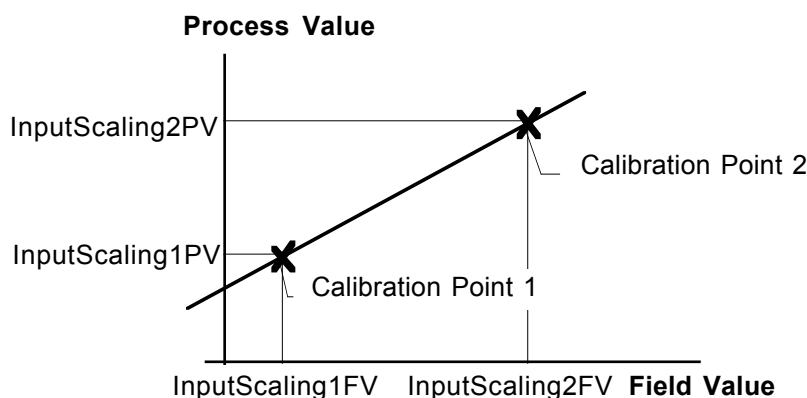

Non-linear transformation (e.g. for thermocouples, PT100 sensors) is Possible and is defined within the parameter "Sensor Type". Then the input scaling values (Input Scaling 1 FV, Input Scaling 1 PV, Input Scaling 2 FV, Input Scaling 2 PV) are meaningless.

The calibration characteristic can be shifted by an additional "**input offset**" value.

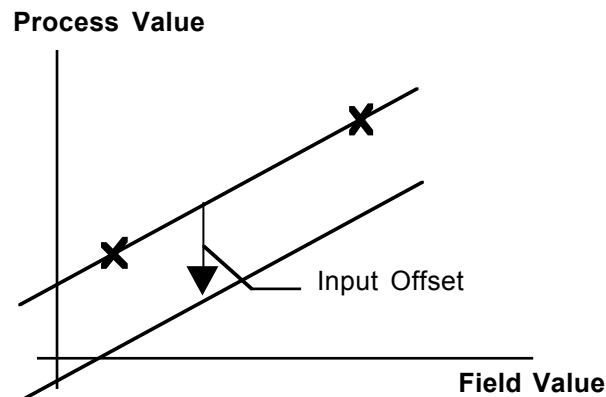

Writing "1" to **auto-zero** will set the zero offset value so that the instantaneous measured process value becomes zero.

The **tare-zero** value works like the zero offset value but results in an additional "net process value".

Writing "1" to **auto-tare** will set the tare zero value so that the instantaneous measured net process value will become zero.

The parameters "**Span Start**" and "**Span End**" define the validity range for the process value. If process value exceeds these limits it will be marked as "overflowed".

Auto-calibration starts a cycle where the sensor signal is temporarily replaced by a reference signal and internal errors of the measuring components are corrected.

Test-Mode defines a static switch of the input lines to internal reference signals for testing purposes.

4.2.3 Digital output function block

If Module incorporates digital output lines they are addressed by a subset of the CANopen device profile according to /3/. Only 1 and 8 Bit access are defined.

4.2.4 Analogue output function block

The analogue output function block describes how process values are converted to analogue output signals (called output field value).

Examples for **output process values** could be:

- Value in kg for weight measurement
- Value in Centigrade for temperature measurement
- Value in mm for displacement measurement
- Value in Bar for pressure measurement

Examples for **output field values** could be:

- unscaled values for digital-analogue converter
- calibrated electrical value for output signal of device (mA, V)

The conversion from output process values to output field values is generally described as a linear transformation. This is defined by two pairs of process values and corresponding output field value (Output Scaling 1 PV / Output Scaling 1 FV and Output Scaling 2 PV / Output Scaling 2 FV).

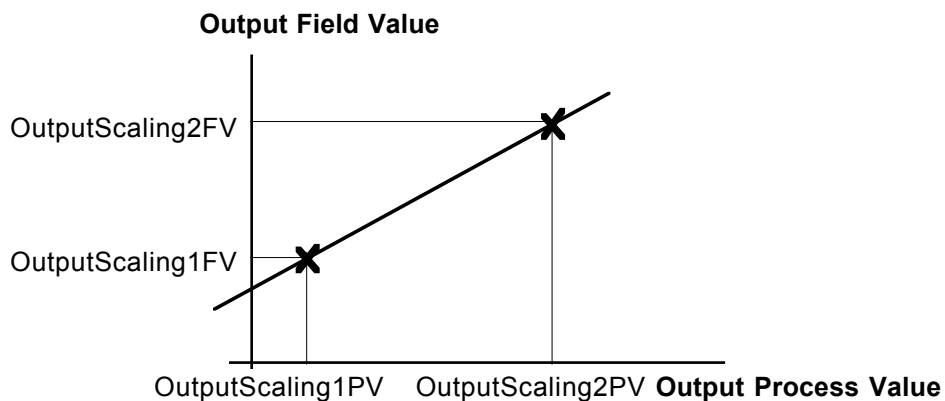

4.2.5 Controller function block

The controller function block describes the PID algorithm for controlling all kinds of process values. The process value might be temperature, pressure, mass flow or any other physical value. The PID controller allows two set-points, a manual override and a self-optimisation.

The controller can be configured as a two-point controller or three-point controller. In the two-point controller mode, the PID algorithm uses the parameters Proportional Band $Xp1$, Integral Action Time $Tn1$, Derivative Action Time $Tv1$ and the Cycle Time $T1$. In the three-point controller mode the parameters $Xp2$, $Tn2$, $Tv2$ and $T2$ will be used, too.

The output of the controller can be limited, e.g. to insure a minimum and a maximum pressure. The output of the controller is a read-only variable. Via the self-optimisation algorithm it is Possible to calculate the necessary PID parameters automatically. Because of different implementations by the manufacturer the starting conditions has to be noticed.

The two Possible set points (W and $W2$) can only be set within the limits of the objects „Lower Set Point Limit, ($W0$) and „Upper Set Point Limit, ($W100$). The switching between these set points is performed via the set point switch.

If the controller is configured as three-point controller, a neutral zone can be defined by the parameters $Xsh1$ and $Xsh2$. These parameters have the same physical unit as the current value.

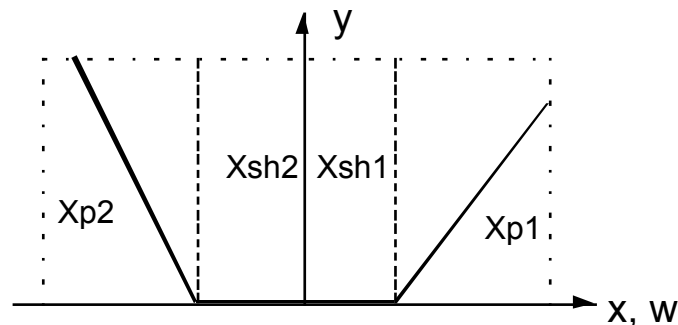

If the controller is configured as three-point stepping controller, a motor response time (Tm) has to be defined. The value for Xsd can be calculated by the equation

$$Xsd = (Tpuls/2) * 0,1 (Xp/Tm).$$

The motor is controlled as shown in the following figure:

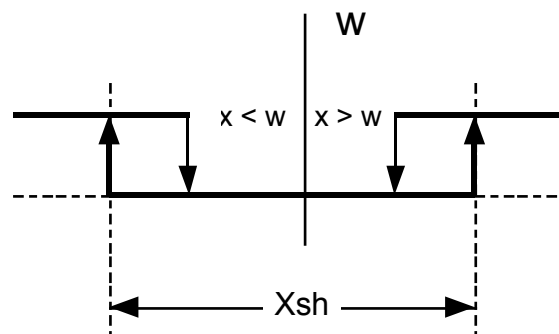

The parameters Xsd1, Xsd2 and LW are used to control a signaller with an additional contact. In that case Xsd1 is the switching difference of signaller and Xsd2 is the switching difference of the additional contact. The parameter LW describes the trigger point separation of the additional contact.

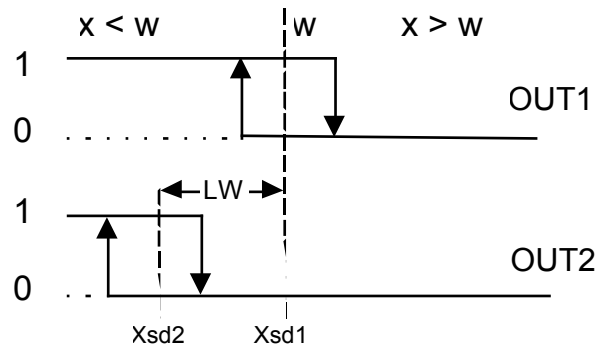

4.2.6 Alarm function block

The alarm function block is able to generate alarm messages according to pre-defined alarm conditions like sensor fault, signal value exceeding specified signal levels, difference between two signals exceeding specified level etc. The output of the alarm function block can be mapped to a PDO or may be mapped directly to an output line of the digital output function block. Entering alarm state can also trigger the transmission of emergency messages.

The alarm function block defines objects for up to 16 alarm trigger definitions per channel.

The **Input Value** is compared to **Level** and **Action** is performed when comparison meets the condition specified in **Type**. When for the comparison two input signals are required, the difference between **Input Value** and **Alternate Input Value** is calculated. Input Value and Alternate Input Value may be mapped to a receive PDO or linked to an output of any other function module (analogue input, controller etc.) by **Link** object (e.g. objects 6503h, 6505h). Alarm outputs can be grouped into one of 8 Possible **Groups**, the group alarm is build by a logical or function of the individual alarm states within this group.

Alarms with starting condition are only generated after alarm condition once reaches fault (off) state (after alarm reset). When an alarm **Reset** is performed the state of the alarm is set to off state when input value is within hysteresis and starting condition is reset (relevant only for alarm types with starting condition).

4.2.7 Device function block

This function block includes all objects, which are generally used to control the device.

5 ERROR HANDLING

5.1 Principle

Emergency Messages are triggered by internal errors in the device and they are assigned the highest Possible priority to ensure that they get access to the bus without latency. By default, the Emergency Messages contain the error field with pre-defined error numbers and additional information.

5.2 Error behaviour

If a serious device failure is detected the module shall enter by default autonomously the pre-operational state. If object **1029h** is implemented, the device can be configured to enter alternatively the stopped state or remain in the current state in case of an device failure. Device failures shall include the following communication errors:

- Bus-off conditions of the CAN interface
- Life guarding event with the state 'occurred'
- Heartbeat event with state 'occurred'
- Stop Remote Node indication

Serious device errors also can be caused by device internal failures.

5.3 Error code meanings

The error codes are used according to the ones defined within /2/. Within this profile some additional profile specific error codes are defined as follow:

Error Code	Meaning
2110h	Short circuit
2310h	Current at outputs too high (Overload)
2320h	Short circuit at outputs
2330h	Load dump at outputs
5010h	Self Test
5020h	Auto-calibration
5030h	Sensor fault
5031h	Fraction of sensor
5032h	Short circuit of sensor
6310h	Calibration
6311h	Input Calibration
6312h	Output Calibration
6320h	Controller parameters
F001h	Input Overload
F002h	Output Overload
F011h	Limit Exceeded
F020h	Tara Overflow
F030h	Self-Optimisation failed

5.4 Additional error codes

The additional error code uses the following format

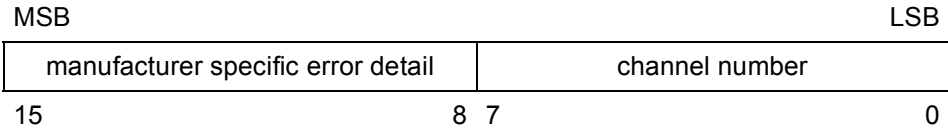

The least significant byte of the additional error code contains the channel number, where the error occurred (for multiple channel devices). The most significant byte of the additional error code can be used manufacturer specific to give more detailed explanation of the error reason.

6 PRE-DEFINITIONS

6.1 Principle

As a device may include a set of different functional blocks there are more than the four standard PDO's pre-defined. If there are more than 5 PDO's used the corresponding COB-ID needs to be configured.

6.2 Naming conventions

The first three characters of CMS name is a device profile identification and is defined for this device profile as: <404>. (According to the number of this standard).

6.3 PDO Mapping

The default mapping defines default values for communication objects 1000h to 1FFFh which are not defined by the communication profile (see /2/).

6.3.1 Object 1000h: Device type

The object at index 1000h describes the type of device and its functionality.

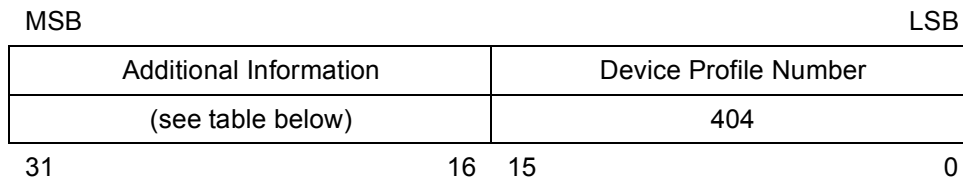

Figure 2: Structure of the Device Type Parameter

Additional information

Bit	Description
16	digital input block
17	analogue input block
18	digital output block
19	analogue output block
20	controller block
21	alarm block
22	reserved
:	:
31	reserved

Bit description:

0 - function block is not present

1 - function block is present

Example: Device with analogue input and alarm function has a device type of 0022 0194h.

6.3.2 Object 1001h: Error Register

The device specific bit in the status word is reserved for future use.

6.3.3 Object 1029h: Error Behaviour

This object specifies to which state an I/O module shall be set, when a communication error, output error or input error is detected.

OBJECT DESCRIPTION

Index	1029h
Name	Error Behaviour
Object Code	ARRAY
Data Type	Unsigned8
Category	Optional

ENTRY DESCRIPTION

Sub-Index	0h
Description	Number of Error Classes
Data Type	Unsigned8
Access	ro
Entry Category	Mandatory
PDO Mapping	No
Value Range	1 – 7h
Default Value	No

Sub-Index	1h
Description	Communication Error
Access	rw
Entry Category	Mandatory
PDO Mapping	No
Value Range	see /2/
Default Value	0

Sub-Index	2h
Description	Digital Input Error
Access	rw
Entry Category	Optional
PDO Mapping	No
Value Range	see /2/
Default Value	0

Sub-Index	3h
Description	Analogue Input Error
Access	rw
Entry Category	Optional
PDO Mapping	No
Value Range	see /2/
Default Value	0

Sub-Index	4h
Description	Digital Output Error
Access	rw
Entry Category	Optional
PDO Mapping	No
Value Range	see /2/
Default Value	0

Sub-Index	5h
Description	Analogue Output Error
Access	rw
Entry Category	Optional
PDO Mapping	No
Value Range	see /2/
Default Value	0

Sub-Index	6h
Description	Controller Error
Access	rw
Entry Category	Optional
PDO Mapping	No
Value Range	see /2/
Default Value	0

Sub-Index	7h
Description	Alarm Error
Access	rw
Entry Category	Optional
PDO Mapping	No
Value Range	see /2/
Default Value	0

Note: If this object is not implemented the device shall be set into pre-operational state in the case a communication error is detected.

6.3.4 1st receive PDO parameters (Received Process Values)

Index	Sub-Index	Comment	Default Value
1400h	0h	number of entries	see /2/
	1h	COB-ID used by PDO	see /2/
	2h	transmission type	255
	3h	inhibit time	0
	4h	reserved	
	5h	event timer	0

Index	Sub-Index	Comment	Default Value
-------	-----------	---------	---------------

1600h	0h	number of mapped objects	2
	1h	Received PV 32	9F50 0120h
	2h	Received Status	6F52 0108h

6.3.5 1st transmit PDO parameters (Analogue Input)

This PDO is used to transmit input measuring values periodically. By default the transmission of this PDO is initiated by the elapsing of the event timer or as specified by object x133h.

If the transmission type 254 is used, the PDO is transmitted dependent on object x133h. The value of the process value has to change more than the value defined in object x133h between two consecutive transmissions. By default, the signal input is disabled by object 6112h,

Index	Sub-Index	Comment	Default Value
1800h	0h	number of entries	see /2/
	1h	COB-ID used by PDO	see /2/
	2h	transmission type	255
	3h	inhibit time	0
	4h	reserved	
	5h	event timer	1000

Index	Sub-Index	Comment	Default Value
1A00h	0h	number of mapped objects	2 or 3
	1h	AI Input PV 32	9130 0120h
	2h	AI Status	6150 0108h
	3h	AL 1..8 State *	6600 0108h

*) if available

6.3.6 2nd receive PDO parameters (Command Values for Controller)

Index	Sub-Index	Comment	Default Value
1401h	0h	number of entries	see /2/
	1h	COB-ID used by PDO	see /2/
	2h	transmission type	255
	3h	inhibit time	0
	4h	reserved	
	5h	event timer	0

Index	Sub-Index	Comment	Default Value
1601h	0h	number of mapped objects	3
	1h	CO Set Point W 16	7402 0110h
	2h	CO Manual Controller Output	6412 0110h
	3h	CO Control Byte	6425 0108h

6.3.7 2nd transmit PDO parameters (Effective Controller Output)

This PDO is used to transmit the effective controller output values. The transmission of this PDO is initiated by the elapsing of CO Cycle Time T1 or CO Cycle Time T2.

Index	Sub-Index	Comment	Default Value
1801h	0h	number of entries	see /2/
	1h	COB-ID used by PDO	see /2/
	2h	transmission type	255
	3h	inhibit time	0
	4h	reserved	
	5h	event timer	0

Index	Sub-Index	Comment	Default Value
1A01h	0h	number of mapped objects	4
	1h	CO Effective Controller Output	6410 0110h
	2h	CO Effective Current Value 16	7400 0110h
	3h	CO Status Information	6427 0108h
	4h	AL 1..8 State	6600 0108h

6.3.8 3rd receive PDO parameters (alternate received process value)

Index	Sub-Index	Comment	Default Value
1402h	0h	number of entries	see /2/
	1h	COB-ID used by PDO	see /2/
	2h	transmission type	255
	3h	inhibit time	0
	4h	reserved	
	5h	event timer	0

Index	Sub-Index	Comment	Default Value
1602h	0h	number of mapped objects	2
	1h	Alternate Received PV 32	9F51 0120h
	2h	Alternate Received Status	6F53 0108h

6.3.9 3rd transmit PDO parameters (alarm)

By default this PDO is transmitted by a change of the alarm state.

Index	Sub-Index	Comment	Default Value	
1802h	0h	number of entries	see /2/	
	1h	COB-ID used by PDO	see /2/	
	2h	transmission type	255	
	3h	inhibit time	0	
	4h	reserved		
	5h	event timer	0	

Index	Sub-Index	Comment	Default Value
1A02h	0h	number of mapped objects	3
	1h	AL 1..8 State	6600 0108h
	2h	AL 9..16 State	6601 0108h
	3h	AL Group 1..8 State	6603 0108h

6.3.10 4th receive PDO parameters (Digital Output)

Index	Sub-Index	Comment	Default Value	
1403h	0h	number of entries	see /2/	
	1h	COB-ID used by PDO	see /2/	
	2h	transmission type	255	
	3h	inhibit time	0	
	4h	reserved		
	5h	event timer	0	

Index	Sub-Index	Comment	Default Value
1603h	0h	number of mapped objects	8
	1h	DO Write State 8 Output Lines	6200 0108h
	2h	DO Write State 8 Output Lines	6200 0208h
	3h	DO Write State 8 Output Lines	6200 0308h
	4h	DO Write State 8 Output Lines	6200 0408h
	5h	DO Write State 8 Output Lines	6200 0508h
	6h	DO Write State 8 Output Lines	6200 0608h
	7h	DO Write State 8 Output Lines	6200 0708h
	8h	DO Write State 8 Output Lines	6200 0808h

6.3.11 4th transmit PDO parameters (Digital Input)

This PDO is transmitted by default when there is any change in the digital input lines.

Index	Sub-Index	Comment	Default Value
1803h	0h	number of entries	see /2/
	1h	COB-ID used by PDO	see /2/
	2h	transmission type	255
	3h	inhibit time	0
	4h	reserved	
	5h	event timer	0

Index	Sub-Index	Comment	Default Value
1A03h	0h	number of mapped objects	8
	1h	DI Read state 8 Input Lines	6000 0108h
	2h	DI Read state 8 Input Lines	6000 0208h
	3h	DI Read state 8 Input Lines	6000 0308h
	4h	DI Read state 8 Input Lines	6000 0408h
	5h	DI Read state 8 Input Lines	6000 0508h
	6h	DI Read state 8 Input Lines	6000 0608h
	7h	DI Read state 8 Input Lines	6000 0708h
	8h	DI Read state 8 Input Lines	6000 0808h

6.3.12 5th receive PDO parameters (Control Bytes)

Index	Sub-Index	Comment	Default Value
1404h	0h	number of entries	see /2/
	1h	COB-ID used by PDO	see /2/
	2h	transmission type	255
	3h	inhibit time	0
	4h	reserved	
	5h	event timer	0

Index	Sub-Index	Comment	Default Value
1604h	0h	number of mapped objects	2
	1h	AI Control Byte	6160 0108h
	2h	CO control byte	6425 0108h

6.3.13 6th receive PDO parameters (Multiplexor PDO)

This PDO is defined according to /2/. It can be used to write to any object in the object dictionary and may be useful in devices with a large number of channels.

Index	Sub-Index	Comment	Default Value
1404h	0h	number of entries	see /2/
	1h	COB-ID used by PDO	see /2/
	2h	transmission type	255
	3h	inhibit time	0
	4h	reserved	
	5h	event timer	0

Index	Sub-Index	Comment	Default Value
1604h	0h	number of mapped objects (Multiplexor PDO)	255

7 OBJECT DICTIONARY

In many applications it is not suitable to stick to a specific data type. In a pure temperature controller application it may be sufficient to transmit the current value as Integer16, whereas in a pressure controller application it may be convenient to use floating point numbers. For this reason the device profile supports four different data types: floating point numbers (Float) as well as 16 bit, 24 bit and 32 bit integers (Integer16, Integer24 and Integer32). To have a better access to the objects in the dictionary, it is divided into four sections:

Index	Data Type
6000h ... 6FFFh	Floating point numbers (Float)
7000h ... 7FFFh	Integer16
8000h ... 8FFFh	Integer24
9000h ... 9FFFh	Integer32

As mentioned in section 4, the universal device is divided in several function blocks. To give the user an easy access to the dictionary, the following structure is used:

Index	Data Type
x000h ... x0FFh	Digital input block
x100h ... x1FFh	Analogue input block
x200h ... x2FFh	Digital output block
x300h ... x3FFh	Analogue output block
x400h ... x4FFh	Controller block
x500h ... x5FFh	Alarm function block
x600h ... xEFFh	reserved
xF00h ... xFFFh	Device function block

The letter „x“ has to be replaced by the number 6, 7, 8, or 9 for the data type.

7.1 Survey object dictionary

7.1.1 Digital input function block

If Module incorporates digital input lines they may be addressed by the CANopen device profile according to device profile specified in /3/. Only 1 and 8 Bit access is defined.

Index	Object Code	Description	Data Type	Acc	PDO mapping	Category
6000h	ARRAY	DI Read state 8 Input Lines	Unsigned8	ro	Possible	C
6002h	ARRAY	DI Polarity 8 Input Lines	Unsigned8	rw	No	O
6020h	ARRAY	DI Read state 1 Input Lines	Boolean	ro	Possible	O
6030h	ARRAY	DI Polarity 1 Input Lines	Boolean	rw	No	O

7.1.2 Analogue input function block

Index	Object Code	Description	Data Type	Acc	PDO mapping	Category
x100h	ARRAY	AI Input FV	spec. by index	ro	Possible	C/O
6101h	reserved					
6102h	reserved					
x103h	ARRAY	AI Interrupt delta input FV	spec. by index	rw	No	O
Sensor:						
6110h	ARRAY	AI Sensor type	Unsigned16	rw	No	O
6111h	ARRAY	AI Autocalibration	Unsigned32	wo	No	O
6112h	ARRAY	AI Operating mode	Unsigned8	rw	No	O
6113h	reserved					
6114h	ARRAY	AI ADC sample rate	Unsigned32	ro	No	O
Scaling:						
x120h	ARRAY	AI Input scaling 1 FV	spec. by index	rw	No	O
x121h	ARRAY	AI Input scaling 1 PV	spec. by index	rw	No	O
x122h	ARRAY	AI Input scaling 2 FV	spec. by index	rw	No	O
x123h	ARRAY	AI Input scaling 2 PV	spec. by index	rw	No	O
x124h	ARRAY	AI Input offset	spec. by index	rw	No	O
6125h	ARRAY	AI Autozero	Unsigned32	wo	No	O
6126h	ARRAY	AI Scaling factor	Float	rw	No	O
6127h	ARRAY	A Scaling offset	Float	rw	No	O
Process value reading:						
x130h	ARRAY	AI Input PV	spec. by index	ro	Possible	C
6131h	ARRAY	AI Physical unit PV	Unsigned32	rw	No	C
6132h	ARRAY	AI Decimal digits PV	Unsigned8	rw	No	C
x133h	ARRAY	AI Interrupt delta input PV	spec. by index	rw	No	O

Index	Object Code	Description	Data Type	Acc	PDO mapping	Category
x134h	ARRAY	AI Interrupt lower limit input PV	spec. by index	rw	No	O
x135h	ARRAY	AI Interrupt upper limit input PV	spec. by index	rw	No	O
Tara unit:						
x138h	ARRAY	AI Tare zero	spec. by index	rw	No	O
6139h	ARRAY	AI Autotare	Unsigned32	wo	No	O
x140h	ARRAY	AI Net PV	spec. by index	ro	Possible	O
x143h	ARRAY	AI Interrupt delta net PV	spec. by index	rw	No	O
x144h	ARRAY	AI Interrupt lower limit net PV	spec. by index	rw	No	O
x145h	ARRAY	AI Interrupt upper limit net PV	spec. by index	rw	No	O
Overflow limits for process values:						
x148h	ARRAY	AI Span start	spec. by index	rw	No	O
x149h	ARRAY	AI Span end	spec. by index	rw	No	O
Input status:						
6150h	ARRAY	AI Status	Unsigned8	ro	Possible	O
6160h	ARRAY	AI Control byte	Unsigned8	wo	Possible	O
6161h	ARRAY	AI Control byte enable	Unsigned8	rw	No	O
61A0h	ARRAY	AI Filter type	Unsigned8	rw	No	O
61A1h	ARRAY	AI Filter constant	Unsigned16	rw	No	O

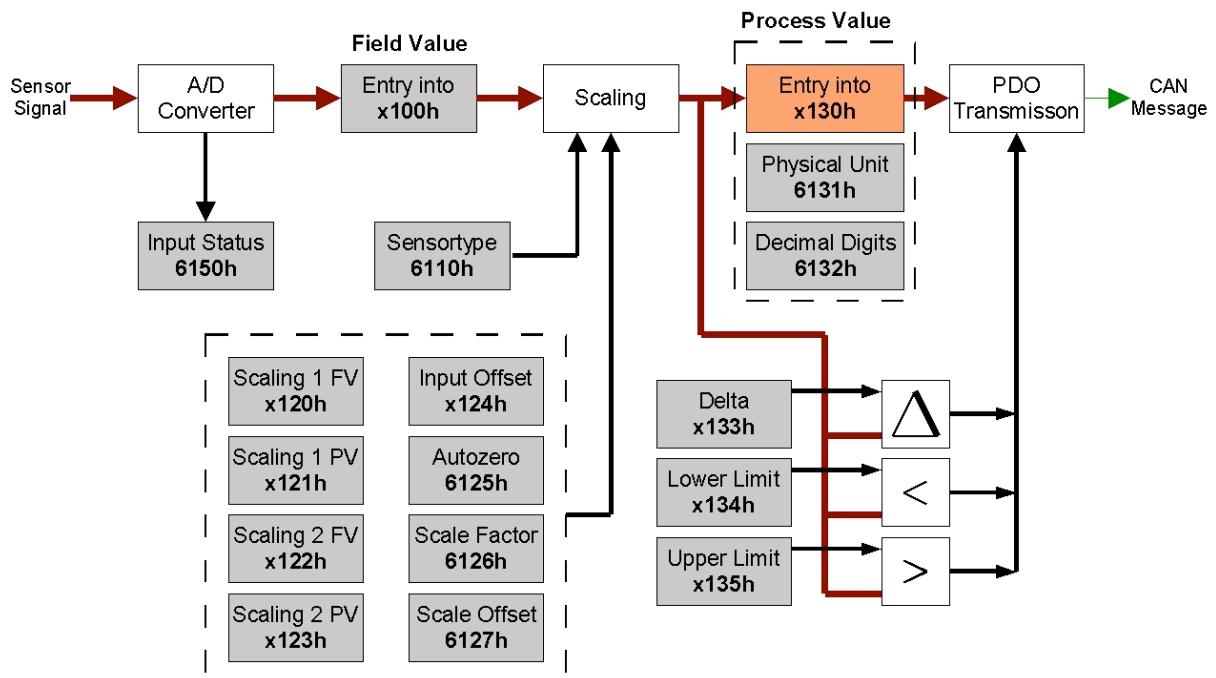

7.1.3 Digital output function block

If Module incorporates digital output lines they may be addressed by the CANopen device profile according to device profile specified in /3/. Only 1 and 8 Bit access is defined.

Index	Object Code	Description	Data Type	Acc	PDO mapping	Category
6200h	ARRAY	DO Write state 8 output lines	Unsigned8	rw	Possible	C
6202h	ARRAY	DO Polarity 8 output lines	Unsigned8	rw	No	O
6206h	ARRAY	DO Fault mode 8 output lines	Unsigned8	rw	No	O
6207h	ARRAY	DO Fault state 8 output lines	Unsigned8	rw	No	O
6210h	RECORD	DO Link object 8 output lines	PDOMapping	rw	No	O
6220h	ARRAY	DO Write state 1 output lines	Boolean	rw	Possible	O
6240h	ARRAY	DO Polarity 1 output lines	Boolean	rw	No	O
6250h	ARRAY	DO Fault mode 1 output lines	Boolean	rw	No	O
6260h	ARRAY	DO Fault state 1 output lines	Boolean	rw	No	O
6280h	RECORD	DO Link object 1 output lines	PDOMapping	rw	No	O

7.1.4 Analogue output function block

Index	Object Code	Description	Data Type	Acc	PDO mapping	Category
x300h	ARRAY	AO Output PV	spec. by index	rw	Possible	O
6301h	ARRAY	AO Physical unit PV	Unsigned32	rw	No	O
6302h	ARRAY	AO Decimal digits PV	Unsigned8	rw	No	O
6303h	RECORD	AO Link output PV	PDOMapping	rw	No	O
6310h	ARRAY	AO Output type	Unsigned16	rw	No	O
x320h	ARRAY	AO Output scaling 1 PV	spec. by index	rw	No	O
x321h	ARRAY	AO Output scaling 1 FV	spec. by index	rw	No	O
x322h	ARRAY	AO Output scaling 2 PV	spec. by index	rw	No	O
x323h	ARRAY	AO Output scaling 2 FV	spec. by index	rw	No	O
x330h	ARRAY	AO Output FV	spec. by index	rw	Possible	O
6331h	ARRAY	AO Physical unit FV	Unsigned32	rw	No	O
6332h	ARRAY	AO Decimal digits FV	Unsigned8	rw	No	O
6340h	ARRAY	AO Fault mode	Unsigned8	rw	No	O
x341h	ARRAY	AO Fault FV	spec. by index	rw	No	O

7.1.5 Controller function block

Index	Object Code	Description	Data Type	Acc	PDO mapping	Category
x400h	ARRAY	CO Effective current value X _{eff}	spec. by index	rw	Possible	M
x401h	ARRAY	CO Effective set point W _{eff}	spec. by index	ro	Possible	M
x402h	ARRAY	CO Set point W	spec. by index	rw	Possible	M
x403h	ARRAY	CO 2nd set point W ₂	spec. by index	rw	Possible	M
x404h	ARRAY	CO Lower set point limit W ₀	spec. by index	rw	No	O
x405h	ARRAY	CO Upper set point limit W ₁₀₀	spec. by index	rw	No	O
6406h	ARRAY	CO Physical unit current value / set point	Unsigned32	rw	No	M
6407h	ARRAY	CO Decimal digits current value / set point	Unsigned8	rw	No	M
6410h	ARRAY	CO Effective controller output Y	Unsigned16	ro	Possible	M
6411h	ARRAY	CO Differential controller output Y _{diff}	Unsigned16	ro	Possible	O
6412h	ARRAY	CO Manual controller output	Unsigned16	rw	Possible	O
6413h	ARRAY	CO Lower controller output limit Y _{min}	Unsigned16	rw	No	O
6414h	ARRAY	CO Upper controller output limit Y _{max}	Unsigned16	rw	No	O
6415h	ARRAY	CO Physical unit controller output	Unsigned32	rw	No	M
6416h	reserved					
6420h	ARRAY	CO Set point switch W/W ₂	Boolean	rw	Possible	M
6421h	ARRAY	CO Automatic / manual mode A/M	Boolean	rw	Possible	M
6422h	ARRAY	CO Controller on / off	Boolean	rw	Possible	M
6423h	ARRAY	CO Controller mode	Unsigned8	rw	Possible	M
6424h	ARRAY	CO Self optimization on / off	Boolean	rw	Possible	O
6425h	ARRAY	CO control byte	Unsigned8	rw	Possible	M
6426h	ARRAY	CO control byte enable	Unsigned8	rw	No	O
6427h	ARRAY	CO status word	Unsigned16	ro	Possible	M
x430h	ARRAY	CO Minimum pulse time T _{min1}	spec. by index	rw	No	O
x431h	ARRAY	CO Minimum pulse time T _{min2}	spec. by index	rw	No	O
x432h	ARRAY	CO Motor response time T _m	spec. by index	rw	No	O
x433h	ARRAY	CO Min. pulse length T _{puls}	spec. by index	rw	No	O
6434h	ARRAY	CO Physical unit pulse timing	Unsigned32	rw	No	O
6435h	ARRAY	CO Decimal digits pulse timing	Unsigned8	rw	No	O
x440h	ARRAY	CO Neutral zone 3point X _{sh1}	spec. by index	rw	No	O
x441h	ARRAY	CO Neutral zone 3point X _{sh2}	spec. by index	rw	No	O
x442h	ARRAY	CO Neutral zone 3point stepping X _{sh}	spec. by index	rw	No	O

Index	Object Code	Description	Data Type	Acc	PDO mapping	Category
x443h	ARRAY	CO Switching difference of signaller Xsd1	spec. by index	rw	No	O
x444h	ARRAY	CO Switching difference of add. Contact Xsd2	spec. by index	rw	No	O
x445h	ARRAY	CO Trigger point separation of add. Contact LW	spec. by index	rw	No	O
x450h	ARRAY	CO Proportional band Xp1	spec. by index	rw	No	O
x451h	ARRAY	CO Proportional band Xp2	spec. by index	rw	No	O
x452h	ARRAY	CO Integral action time Tn1	spec. by index	rw	No	O
x453h	ARRAY	CO Integral action time Tn2	spec. by index	rw	No	O
x454h	ARRAY	CO Derivative action time Tv1	spec. by index	rw	No	O
x455h	ARRAY	CO Derivative action time Tv2	spec. by index	rw	No	O
x456h	ARRAY	CO Cycle time T1	spec. by index	rw	No	O
x457h	ARRAY	CO Cycle time T2	spec. by index	rw	No	O
6458h	ARRAY	CO Physical unit PID timing	Unsigned32	rw	No	O
6459h	ARRAY	CO Decimal digits PID timing	Unsigned8	ro	No	O

7.1.6 Alarm function block

Index	Object Code	Description	Data Type	Acc	PDO mapping	Category
x500h	ARRAY	AL 1 Input value	spec. by index	rw	Possible	M
6503h	RECORD	AL 1 Link input	PDOMapping	rw	No	O
x504h	ARRAY	AL 1 Alternate input value	spec. by index	rw	No	O
6505h	RECORD	AL 1 Link alternate input	PDOMapping	rw	No	O
6506h	ARRAY	AL 1 Fault mode	Unsigned8	rw	No	O
6507h	ARRAY	AL 1 Fault state	Boolean	rw	No	O
6508h	ARRAY	AL 1 Type	Unsigned8	rw	No	M
6509h	ARRAY	AL 1 Action	Unsigned8	rw	No	M
x50Ah	ARRAY	AL 1 Level	spec. by index	rw	No	M
x50Bh	ARRAY	AL 1 Hysteresis	spec. by index	rw	No	O
650Ch	ARRAY	AL 1 Group	Unsigned8	rw	No	O
650Dh	ARRAY	AL 1 State	Boolean	ro	Possible	O
650Eh	ARRAY	AL 1 Reset	Boolean	wo	No	O
.....
x5F0h	ARRAY	AL 16 Input value	spec. by index	rw	Possible	M
65F3h	RECORD	AL 16 Link input	PDOMapping	rw	No	O
x5F4h	ARRAY	AL 16 Alternate input value	spec. by index	rw	No	O
65F5h	RECORD	AL 16 Link alternate input	PDOMapping	rw	No	O
65F6h	ARRAY	AL 16 Fault mode	Unsigned8	rw	No	O
65F7h	ARRAY	AL 16 Fault state	Boolean	rw	No	O
65F8h	ARRAY	AL 16 Type	Unsigned8	rw	No	M
65F9h	ARRAY	AL 16 Action	Unsigned8	rw	No	M
x5FAh	ARRAY	AL 16 Level	spec. by index	rw	No	M
x5FBh	ARRAY	AL 16 Hysteresis	spec. by index	rw	No	O
65FCh	ARRAY	AL 16 Group	Unsigned8	rw	No	O
65FDh	ARRAY	AL 16 State	Boolean	ro	Possible	O
65FEh	ARRAY	AL 16 Reset	Boolean	wo	No	O
6600h	ARRAY	AL 1..8 State	Unsigned8	ro	Possible	M
6601h	ARRAY	AL 9..16 State	Unsigned8	ro	Possible	O
6602h	VAR	AL General state	Boolean	ro	Possible	O
6603h	VAR	AL Group 1..8 State	Unsigned8	ro	Possible	O
6610h	VAR	AL General Reset	Boolean	wo	Possible	O
6611h	ARRAY	AL 1..8 Reset	Unsigned8	wo	Possible	O
6612h	ARRAY	AL 9..16 Reset	Unsigned8	wo	Possible	O

- Alarm output lines are configured by using the output function block and linking the lines to the alarm state. Here also polarity etc. can be defined for these output lines.
- Splitting the Alarm State 1..8 and 9..16 into two single byte objects helps keeping PDOs small when Not more than 8 alarms are used.
- Several alarms can be combined by logical „or“ function into group alarms.
- The alarm interrupt will cause asynchronous transmission of 3rd transmit PDO.

7.1.7 Device function block

Index	Object Code	Description	Data Type	Acc	PDO mapping	Category
6F20h	ARRAY	Life counter	Unsigned8	ro	Possible	O
6F30h	ARRAY	Receive PDO check	Unsigned8	wo	Possible	O
6F31h	ARRAY	Transmit PDO check	Unsigned8	ro	Possible	O
xF50h	ARRAY	Received PV	spec. by index	rw	Possible	M
xF51h	ARRAY	Alternate received PV	spec. by index	rw	Possible	O
6F52h	ARRAY	Received status	Unsigned8	rw	Possible	M
6F53h	ARRAY	Alternate received status	Unsigned8	rw	Possible	O
6F60h	VAR	Transmission enable	Boolean	rw	No	O

7.2 Detailed object specification

7.2.1 Object 6000h: DI Read state 8 Input Lines

This object shall read groups of 8 input lines as 8-bit information. A maximum of 199 x 8-bit inputs is addressable (1592 inputs). This object is mandatory for modules, which supports digital input lines, and shall support all implemented input lines.

OBJECT DESCRIPTION

Index	6000h
Name	DI Read state 8 Input Lines
Object Code	ARRAY
Data Type	Unsigned8
Category	Conditional: device with digital inputs

ENTRY DESCRIPTION

Sub-Index	0h
Description	number of entries
Access	ro
Entry Category	Mandatory
PDO Mapping	No
Value Range	1 - C7h
Default Value	No

Sub-Index	1h
Description	DI Read state 8 Input Lines 1
Access	ro
Entry Category	Mandatory
PDO Mapping	Possible
Value Range	Unsigned8
Default Value	No

Sub-Index	2h
Description	DI Read state 8 Input Lines 2
Access	ro
Entry Category	Optional
PDO Mapping	Possible
Value Range	Unsigned8
Default Value	No

to

Sub-Index	C7h
Description	DI Read state 8 Input Lines 199
Access	ro
Entry Category	Optional
PDO Mapping	Possible
Value Range	Unsigned8
Default Value	No

7.2.2 Object 6002h: DI Polarity 8 Input Lines

This object shall define the polarity of a group of 8 input lines. Input polarity can be inverted individually.

0 = input not inverted

1 = input inverted

If the object is not supported the device shall behave accordingly to the default value.

OBJECT DESCRIPTION

Index	6002h
Name	DI Polarity 8 Input Lines
Object Code	ARRAY
Data Type	Unsigned8
Category	Optional

ENTRY DESCRIPTION

Sub-Index	0h
Description	number of entries
Access	ro
Entry Category	Mandatory
PDO Mapping	No
Value Range	1 - C7h
Default Value	No

Sub-Index	1h
Description	DI Polarity 8 Input Lines 1
Access	rw
Entry Category	Mandatory
PDO Mapping	No
Value Range	Unsigned8
Default Value	0

Sub-Index	2h
Description	DI Polarity 8 Input Lines 2
Access	rw
Entry Category	Optional
PDO Mapping	No
Value Range	Unsigned8
Default Value	0

to

Sub-Index	C7h
Description	DI Polarity 8 Input Lines 199
Access	Rw
Entry Category	Optional
PDO Mapping	No
Value Range	Unsigned8
Default Value	0

7.2.3 Object 6020h: DI Read state 1 Input Lines

This object shall read single input lines information. A maximum of 199 input lines is addressable at this index.

OBJECT DESCRIPTION

Index	6020h
Name	DI Read state 1 Input Lines
Object Code	ARRAY
Data Type	Boolean
Category	Optional

ENTRY DESCRIPTION

Sub-Index	0h
Description	number of entries
Access	ro
Entry Category	Mandatory
PDO Mapping	No
Value Range	1 - C7h
Default Value	No

Sub-Index	1h
Description	DI Read state 1 Input Lines 1
Data Type	Boolean
Access	ro
Entry Category	Mandatory
PDO Mapping	Possible
Value Range	Boolean
Default Value	No

Sub-Index	2h
Description	DI Read state 1 Input Lines 2
Data Type	Boolean
Access	ro
Entry Category	Optional
PDO Mapping	Possible
Value Range	Boolean
Default Value	No

to

Sub-Index	C7h
Description	DI Read state 1 Input Lines 199
Data Type	Boolean
Access	ro
Entry Category	Optional
PDO Mapping	Possible
Value Range	Boolean
Default Value	No

7.2.4 Object 6030h: DI Polarity 1 Input Lines

This object shall define the polarity of single input lines. A maximum of 199 input lines is addressable at this index.

0 = input not inverted

1 = input inverted

If the object is not supported the device shall behave accordingly to the default value.

OBJECT DESCRIPTION

Index	6030h
Name	DI Polarity 1 Input Lines
Object Code	ARRAY
Data Type	Boolean
Category	Optional

ENTRY DESCRIPTION

Sub-Index	0
Description	number of entries
Access	ro
Entry Category	Mandatory
PDO Mapping	No
Value Range	1 - C7h
Default Value	No

Sub-Index	1h
Description	DI Polarity 1 Input Lines 1
Access	rw
Entry Category	Mandatory
PDO Mapping	No
Value Range	Boolean
Default Value	0

Sub-Index	2h
Description	DI Polarity 1 Input Lines 2
Access	rw
Entry Category	Optional
PDO Mapping	No
Value Range	Boolean
Default Value	0

to

Sub-Index	C7h
Description	DI Polarity 1 Input Lines 199
Access	rw
Entry Category	Optional
PDO Mapping	No
Value Range	Boolean
Default Value	0

7.2.5 Object x100h: AI Input FV

This object represents the converted value of an analogue input module, which is not yet scaled to the physical unit of the quantity being measured. Scaling could be e.g. digits of the analogue digital converter used or Ohms for Pt100 temperature measurement.

The value shall be always left adjusted. The remaining bits are at the right side of the LSB shall be set to zero.

OBJECT DESCRIPTION

Index	x100h
Name	AI Input FV
Object Code	ARRAY
Data Type	Float, Integer16, Integer24, Integer32
Category	Optional

ENTRY DESCRIPTION

Sub-Index	0h
Description	number of entries
Access	ro
Entry Category	Mandatory
PDO Mapping	No
Value Range	1 - C7h
Default Value	No

Sub-Index	1h
Description	AI Input FV 1
Access	ro
Entry Category	Mandatory
PDO Mapping	Possible
Value Range	Data type specific
Default Value	No

Sub-Index	2h
Description	AI Input FV 2
Access	ro
Entry Category	Optional
PDO Mapping	Possible
Value Range	Data type specific
Default Value	No

to

Sub-Index	C7h
Description	AI Input FV 199
Access	ro
Entry Category	Optional
PDO Mapping	Possible
Value Range	Data type specific
Default Value	No

7.2.6 Object x103h: AI Interrupt delta input FV

When Input Field Value is mapped to a transmit PDO and its value has changed delta or more since the last PDO transmission then the PDO is transmitted again. A delta value of 0 means, that this function is disabled.

OBJECT DESCRIPTION

Index	x103h
Name	AI Interrupt delta input FV
Object Code	ARRAY
Data Type	Float, Integer16, Integer24, Integer32
Category	Optional

ENTRY DESCRIPTION

Sub-Index	0h
Description	number of entries
Entry Category	Mandatory
Access	ro
PDO Mapping	No
Value Range	1 - C7h
Default Value	No

Sub-Index	1h
Description	AI Interrupt delta input FV 1
Entry Category	Mandatory
Access	rw
PDO Mapping	No
Value Range	Data type specific
Default Value	No

Sub-Index	2h
Description	AI Interrupt delta input FV 2
Entry Category	Optional
Access	rw
PDO Mapping	No
Value Range	Data type specific
Default Value	No

to

Sub-Index	C7h
Description	AI Interrupt delta input FV 199
Entry Category	Optional
Access	rw
PDO Mapping	No
Value Range	Data type specific
Default Value	No

7.2.7 Object 6110h: AI Sensor type

Specifies the type of sensor, which is connected to the analogue input.

Value	Meaning
0	reserved
1	Thermocouple type J

Value	Meaning
2	Thermocouple type K
3	Thermocouple type L
4	Thermocouple type N
5	Thermocouple type R
6	Thermocouple type S
7	Thermocouple type T
8 ... 29	reserved (other types of thermocouple)
30	PT100
31	PT200
32	PT500
33	PT1000
34	PT5000
35	IR-Sensor
36 .. 39	reserved
40	Voltage
41	+/- 10 V
42	0 .. 10 V
43	+/- 1 V
44	0 .. 1 V
45	+/- 100 mV
46	0 .. 100 mV
47 .. 49	reserved
50	Current
51	4..20mA
52	0..20mA
53 .. 59	reserved
60	Frequency
61 ... 69	reserved
70	Strain gauge
71	Strain gauge full bridge
72	Strain gauge half bridge
73	Strain gauge quarter bridge
74 .. 79	reserved
80	LVDT
81 .. 89	reserved
90	Pressure Transducer
91 .. 99	reserved
100	Temperature transducer
101 .. 119	reserved
120	Potentiometer
121 ... 9999	reserved
10000 ... 65535	manufacturer specific use

OBJECT DESCRIPTION

Index	6110h
Name	AI Sensor type
Object Code	ARRAY
Data Type	Unsigned16
Category	Optional

ENTRY DESCRIPTION

Sub-Index	0h
Description	number of entries
Entry Category	Mandatory
Access	ro
PDO Mapping	No
Value Range	1 - C7h
Default Value	No

Sub-Index	1h
Description	AI Sensor type 1
Entry Category	Mandatory
Access	rw
PDO Mapping	No
Value Range	Unsigned16
Default Value	No

Sub-Index	2h
Description	AI Sensor type 2
Entry Category	Optional
Access	rw
PDO Mapping	No
Value Range	Unsigned16
Default Value	No

to

Sub-Index	C7h
Description	AI Sensor type 199
Entry Category	Optional
Access	rw
PDO Mapping	No
Value Range	Unsigned16
Default Value	No

7.2.8 Object 6111h: AI Autocalibration

Writing a signature value of „cali“ to this object starts auto-calibration cycle of the analogue input channel for one time.

If a wrong signature is written, the device refuses to calibrate and respond with an abort message (abort code 0800 002xh)

Signature	MSB			LSB
ASCII	i	l	a	c
hex	69	6C	61	63

OBJECT DESCRIPTION

Index	6111h
Name	AI Autocalibration
Object Code	ARRAY
Data Type	Unsigned32
Category	Optional

ENTRY DESCRIPTION

Sub-Index	0h
Description	number of entries
Entry Category	Mandatory
Access	ro
PDO Mapping	No
Value Range	1 - C7h
Default Value	No

Sub-Index	1h
Description	AI Autocalibration 1
Entry Category	Mandatory
Access	wo
PDO Mapping	No
Value Range	Unsigned32
Default Value	No

Sub-Index	2h
Description	AI Autocalibration 2
Entry Category	Optional
Access	wo
PDO Mapping	No
Value Range	Unsigned32
Default Value	No

to

Sub-Index	C7h
Description	AI Autocalibration 199
Entry Category	Optional
Access	wo
PDO Mapping	No
Value Range	Unsigned32
Default Value	No

7.2.9 Object 6112h: AI Operating mode

A value different from 0 sets the analogue input channel to special operating modes.

Value	Meaning
0	Channel off (Not operating)
1	Normal operation
2 ... 9	Reserved
10 ... 255	Implementation specific

OBJECT DESCRIPTION

Index	6112h
Name	AI Operating mode
Object Code	ARRAY
Data Type	Unsigned8
Category	Optional

ENTRY DESCRIPTION

Sub-Index	0
Description	number of entries
Entry Category	Mandatory
Access	ro
PDO Mapping	No
Value Range	1 - C7h
Default Value	No

Sub-Index	1h
Description	AI Operating mode 1
Entry Category	Mandatory
Access	rw
PDO Mapping	No
Value Range	Unsigned8
Default Value	0

Sub-Index	2h
Description	AI Operating mode 2
Entry Category	Optional
Access	rw
PDO Mapping	No
Value Range	Unsigned8
Default Value	0

to

Sub-Index	C7h
Description	AI Operating mode 199
Entry Category	Optional
Access	rw
PDO Mapping	No
Value Range	Unsigned8
Default Value	0

7.2.10 Object 6114h: AI ADC sample rate

This value has to be the conversion rate used by the AD converter. The value is given in multiples of microseconds.

OBJECT DESCRIPTION

Index	6114h
Name	AI ADC sample rate
Object Code	ARRAY
Data Type	Unsigned32
Category	Optional

ENTRY DESCRIPTION

Sub-Index	0
Description	number of entries
Entry Category	Mandatory
Access	ro
PDO Mapping	No
Value Range	1 – C7h
Default Value	No

Sub-Index	1h
Description	AI ADC sample rate 1
Entry Category	Mandatory
Access	ro
PDO Mapping	No
Value Range	Unsigned32
Default Value	0

Sub-Index	2h
Description	AI ADC sample rate 2
Entry Category	Optional
Access	ro
PDO Mapping	No
Value Range	Unsigned32
Default Value	0

to

Sub-Index	C7h
Description	AI ADC sample rate 199
Entry Category	Optional
Access	ro
PDO Mapping	No
Value Range	Unsigned32
Default Value	0

7.2.11 Object x120h: AI Input scaling 1 FV

This object defines the field value of the first calibration point for the analogue input channel. It is scaled in physical unit of field value.

OBJECT DESCRIPTION

Index	x120h
Name	AI Input scaling 1 FV
Object Code	ARRAY
Data Type	Float, Integer16, Integer24, Integer32
Category	Optional

ENTRY DESCRIPTION

Sub-Index	0h
Description	number of entries
Entry Category	Mandatory
Access	ro
PDO Mapping	No
Value Range	1 – 254
Default Value	No

Sub-Index	1h
Description	AI Input scaling 1 FV 1
Entry Category	Mandatory
Access	rw
PDO Mapping	No
Value Range	data type specific
Default Value	No

Sub-Index	2h
Description	AI Input scaling 1 FV 2
Entry Category	Optional
Access	rw
PDO Mapping	No
Value Range	data type specific
Default Value	No

to

Sub-Index	C7h
Description	AI Input scaling 1 FV 199
Entry Category	Optional
Access	rw
PDO Mapping	No
Value Range	data type specific
Default Value	No

7.2.12 Object x121h: AI Input scaling 1 PV

This object defines the process value of the first calibration point for the analogue input channel. It is scaled in physical unit of process value.

OBJECT DESCRIPTION

Index	x121h
Name	AI Input scaling 1 PV
Object Code	ARRAY
Data Type	Float, Integer16, Integer24, Integer32
Category	Optional

ENTRY DESCRIPTION

Sub-Index	0h
Description	number of entries
Entry Category	Mandatory
Access	ro
PDO Mapping	No
Value Range	1 – 254
Default Value	No

Sub-Index	1h
Description	AI Input scaling 1 PV 1
Entry Category	Mandatory
Access	rw
PDO Mapping	No
Value Range	data type specific
Default Value	No

Sub-Index	2h
Description	AI Input scaling 1 PV 2
Entry Category	Optional
Access	rw
PDO Mapping	No
Value Range	data type specific
Default Value	No

to

Sub-Index	C7h
Description	AI Input scaling 1 PV 199
Entry Category	Optional
Access	rw
PDO Mapping	No
Value Range	data type specific
Default Value	No

7.2.13 Object x122h: AI Input scaling 2 FV

This object defines the field value of the second calibration point for the analogue input channel. It is scaled in physical unit of field value.

OBJECT DESCRIPTION

Index	x122h
Name	AI Input scaling 2 FV
Object Code	ARRAY
Data Type	Float, Integer16, Integer24, Integer32
Category	Optional

ENTRY DESCRIPTION

Sub-Index	0
Description	number of entries
Entry Category	Mandatory
Access	ro
PDO Mapping	No
Value Range	1 - C7h
Default Value	No

Sub-Index	1h
Description	AI Input scaling 2 FV 1
Entry Category	Mandatory
Access	rw
PDO Mapping	No
Value Range	data type specific
Default Value	No

Sub-Index	2h
Description	AI Input scaling 2 FV 2
Entry Category	Optional
Access	rw
PDO Mapping	No
Value Range	data type specific
Default Value	No

to

Sub-Index	C7h
Description	AI Input scaling 2 FV 199
Entry Category	Optional
Access	rw
PDO Mapping	No
Value Range	data type specific
Default Value	No

7.2.14 Object x123h: AI Input scaling 2 PV

This object defines the process value of the second calibration point for the analogue input channel. It is scaled in physical unit of process value.

OBJECT DESCRIPTION

Index	x123h
Name	AI Input scaling 2 PV
Object Code	ARRAY
Data Type	Float, Integer16, Integer24, Integer32
Category	Optional

ENTRY DESCRIPTION

Sub-Index	0h
Description	number of entries
Entry Category	Mandatory
Access	ro
PDO Mapping	No
Value Range	1 - C7h
Default Value	No

Sub-Index	1h
Description	AI Input scaling 2 PV 1
Entry Category	Mandatory
Access	rw
PDO Mapping	No
Value Range	data type specific
Default Value	No

Sub-Index	2h
Description	AI Input scaling 2 PV 2
Entry Category	Optional
Access	rw
PDO Mapping	No
Value Range	data type specific
Default Value	No

to

Sub-Index	C7h
Description	AI Input scaling 2 PV 199
Entry Category	Optional
Access	rw
PDO Mapping	No
Value Range	data type specific
Default Value	No

7.2.15 Object x124h: AI Input offset

This object defines the additional offset value for the analogue input channel. It is scaled in physical unit of process value.

OBJECT DESCRIPTION

Index	x124h
Name	AI Input offset
Object Code	ARRAY
Data Type	Float, Integer16, Integer24, Integer32
Category	Optional

ENTRY DESCRIPTION

Sub-Index	0h
Description	number of entries
Entry Category	Mandatory
Access	ro
PDO Mapping	No
Value Range	1 - C7h
Default Value	No

Sub-Index	1h
Description	AI Input offset 1
Entry Category	Mandatory
Access	rw
PDO Mapping	No
Value Range	data type specific
Default Value	0

Sub-Index	2h
Description	AI Input offset 2
Entry Category	Optional
Access	rw
PDO Mapping	No
Value Range	data type specific
Default Value	0

to

Sub-Index	C7h
Description	AI Input offset 199
Entry Category	Optional
Access	rw
PDO Mapping	No
Value Range	data type specific
Default Value	0

7.2.16 Object 6125h: AI Autozero

Writing a signature value of „zero“ to this object causes a modification of the AI Input Offset in such a way that the actual AI Input PV becomes zero. This cycle is performed for one time.

Signature	MSB			LSB
ASCII	o	r	e	z
hex	6f	72	65	7A

OBJECT DESCRIPTION

Index	6125h
Name	AI Autozero
Object Code	ARRAY
Data Type	Unsigned32
Category	Optional

ENTRY DESCRIPTION

Sub-Index	0h
Description	number of entries
Entry Category	Mandatory
Access	ro
PDO Mapping	No
Value Range	1 - C7h
Default Value	No

Sub-Index	1h
Description	AI Autozero 1
Entry Category	Mandatory
Access	wo
PDO Mapping	No
Value Range	Unsigned32
Default Value	No

Sub-Index	2h
Description	AI Autozero 2
Entry Category	Optional
Access	wo
PDO Mapping	No
Value Range	Unsigned32
Default Value	No

to

Sub-Index	C7h
Description	AI Autozero 199
Entry Category	Optional
Access	wo
PDO Mapping	No
Value Range	Unsigned32
Default Value	No

7.2.17 Object x126h: AI Scaling Factor

This object represents the scaling factor by which the field value needs to be multiplied to get process values.

OBJECT DESCRIPTION

Index	6126h
Name	AI Scaling Factor
Object Code	ARRAY
Data Type	Float
Category	Optional

ENTRY DESCRIPTION

Sub-Index	0h
Description	number of entries
Entry Category	Mandatory
Access	ro
PDO Mapping	No
Value Range	1 - C7h
Default Value	No

Sub-Index	1h
Description	AI Scaling Factor 1
Entry Category	Mandatory
Access	rw
PDO Mapping	No
Value Range	Float
Default Value	1

Sub-Index	2h
Description	AI Scaling Factor 2
Entry Category	Optional
Access	rw
PDO Mapping	No
Value Range	Float
Default Value	1

to

Sub-Index	C7h
Description	AI Scaling Factor 199
Entry Category	Optional
Access	rw
PDO Mapping	No
Value Range	Float
Default Value	1

7.2.18 Object 6127h: AI Scaling Offset

This object represents the scaling offset, which is needed to calculate the process values from the field values:

$$\text{Process Value} = (\text{Field Value} * \text{Scaling Factor}) + \text{Scaling Offset}$$

OBJECT DESCRIPTION

Index	6127h
Name	AI Scaling Offset
Object Code	ARRAY
Data Type	Float
Entry Category	Optional

ENTRY DESCRIPTION

Sub-Index	0h
Description	number of entries
Access	ro
Entry Category	Mandatory
PDO Mapping	No
Value Range	1 - C7h
Default Value	No

Sub-Index	1h
Description	AI Scaling Offset 1
Access	rw
Entry Category	Mandatory
PDO Mapping	No
Value Range	Float
Default Value	0

Sub-Index	2h
Description	AI Scaling Offset 2
Access	rw
Entry Category	Optional
PDO Mapping	No
Value Range	Float
Default Value	0

to

Sub-Index	C7h
Description	AI Scaling Offset 199
Access	rw
Entry Category	Optional
PDO Mapping	No
Value Range	Float
Default Value	0

7.2.19 Object x130h: AI Input PV

This object represents the result of the input scaling block and gives the measured quantity scaled in the physical unit of process values (e.g. degrees centigrade, kg, kN, mm etc.).

OBJECT DESCRIPTION

Index	x130h
Name	AI Input PV
Object Code	ARRAY
Data Type	Float, Integer16, Integer24, Integer32
Category	Conditional

ENTRY DESCRIPTION

Sub-Index	0h
Description	number of entries
Entry Category	Mandatory
Access	ro
PDO Mapping	No
Value Range	1 - C7h
Default Value	No

Sub-Index	1h
Description	AI Input PV 1
Entry Category	Mandatory
Access	ro
PDO Mapping	Possible
Value Range	data type specific
Default Value	No

Sub-Index	2h
Description	AI Input PV 2
Entry Category	Optional
Access	ro
PDO Mapping	Possible
Value Range	data type specific
Default Value	No

to

Sub-Index	C7h
Description	AI Input PV 199
Entry Category	Optional
Access	ro
PDO Mapping	Possible
Value Range	data type specific
Default Value	No

7.2.20 Object 6131h: AI Physical unit PV

This object shall assign SI units and prefixes for the process values within the analogue input function block. The structure of the SI unit entry is as follows:

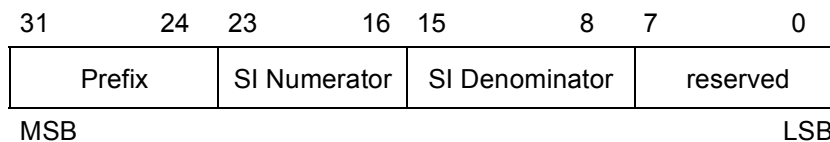

The coding of the physical units and prefixes is done according to the /5/. Within this profile, there are some additional physical units specified:

Code	Physical Unit
55 _h	m/s
56 _h	Nm
A1 _h	at
A2 _h	mmH ₂ O
A3 _h	mHG
A4 _h	atm
AB _h	PSI
AC _h	°F

OBJECT DESCRIPTION

Index	6131h
Name	AI Physical unit PV
Object Code	ARRAY
Data Type	Unsigned32
Category	Conditional

ENTRY DESCRIPTION

Sub-Index	0h
Description	number of entries
Entry Category	Mandatory
Access	ro
PDO Mapping	No
Value Range	1 - C7h
Default Value	No

Sub-Index	1h
Description	AI Physical unit PV 1
Entry Category	Mandatory
Access	rw
PDO Mapping	No
Value Range	Unsigned32
Default Value	No

Sub-Index	2h
Description	AI Physical unit PV 2
Entry Category	Optional
Access	rw
PDO Mapping	No
Value Range	Unsigned32
Default Value	No

to

Sub-Index	C7h
Description	AI Physical unit PV 199
Entry Category	Optional
Access	rw
PDO Mapping	No
Value Range	Unsigned32
Default Value	No

7.2.21 Object 6132h: AI Decimal digits PV

This object describes the number of decimal digits following the decimal point for interpretation of data types Integer8, Integer16 and Integer32.

Example: A field value of 1.230 (Float) will be coded as 123 in Integer16 format if number of decimal digits is set to 2.

OBJECT DESCRIPTION

Index	6132h
Name	AI Decimal digits PV
Object Code	ARRAY
Data Type	Unsigned8
Category	Conditional

ENTRY DESCRIPTION

Sub-Index	0
Description	number of entries
Entry Category	Mandatory
Access	ro
PDO Mapping	No
Value Range	1 - C7h
Default Value	No

Sub-Index	1h
Description	AI Decimal digits PV 1
Entry Category	Mandatory
Access	rw
PDO Mapping	No
Value Range	0 – 9h
Default Value	No

Sub-Index	2h
Description	AI Decimal digits PV 2
Entry Category	Optional
Access	rw
PDO Mapping	No
Value Range	0 – 9h
Default Value	No

to

Sub-Index	C7h
Description	AI Decimal digits PV 199
Entry Category	Optional
Access	rw
PDO Mapping	No
Value Range	0 – 9h
Default Value	No

7.2.22 Object x133h: AI Interrupt delta input PV

When Input Process Value is mapped to a transmit PDO and its value has changed delta or more since the last PDO transmission then the PDO is transmitted again. A delta value of 0 means, that this function is disabled.

OBJECT DESCRIPTION

Index	x133h
Name	AI Interrupt delta input PV
Object Code	ARRAY
Data Type	Float, Integer16, Integer24, Integer32
Category	Optional

ENTRY DESCRIPTION

Sub-Index	0h
Description	number of entries
Entry Category	Mandatory
Access	ro
PDO Mapping	No
Value Range	1 – C7h
Default Value	No

Sub-Index	1h
Description	AI Interrupt delta input PV 1
Entry Category	Mandatory
Access	rw
PDO Mapping	No
Value Range	Data type specific
Default Value	No

Sub-Index	2h
Description	AI Interrupt delta input PV 2
Entry Category	Optional
Access	rw
PDO Mapping	No
Value Range	Data type specific
Default Value	No

to

Sub-Index	C7h
Description	AI Interrupt delta input PV 199
Entry Category	Optional
Access	rw
PDO Mapping	No
Value Range	data type specific
Default Value	No

7.2.23 Object x134h: AI Interrupt lower limit input PV

This object sets the lower limits for interrupt-enabled analogue inputs. The value shall be always left adjusted.

OBJECT DESCRIPTION

Index	x134h
Name	AI Interrupt lower limit input PV
Object Code	ARRAY
Data Type	Float, Integer16, Integer24, Integer32
Category	Optional

ENTRY DESCRIPTION

Sub-Index	0h
Description	number of entries
Entry Category	Mandatory
Access	ro
PDO Mapping	No
Value Range	1 – C7h
Default Value	No

Sub-Index	1h
Description	AI Interrupt lower limit input PV 1
Entry Category	Mandatory
Access	rw
PDO Mapping	No
Value Range	Data type specific
Default Value	No

Sub-Index	2h
Description	AI Interrupt lower limit input PV 2
Entry Category	Optional
Access	rw
PDO Mapping	No
Value Range	Data type specific
Default Value	No

to

Sub-Index	C7h
Description	AI Interrupt lower limit input PV 199
Entry Category	Optional
Access	rw
PDO Mapping	No
Value Range	data type specific
Default Value	No

7.2.24 Object x135h: AI Interrupt upper limit input PV

This object sets the upper limits for interrupt-enabled analogue inputs. The value shall be always left adjusted.

OBJECT DESCRIPTION

Index	x135h
Name	AI Interrupt upper limit input PV
Object Code	ARRAY
Data Type	Float, Integer16, Integer24, Integer32
Category	Optional

ENTRY DESCRIPTION

Sub-Index	0h
Description	number of entries
Entry Category	Mandatory
Access	ro
PDO Mapping	No
Value Range	1 - C7h
Default Value	No

Sub-Index	1h
Description	AI Interrupt upper limit input PV 1
Entry Category	Mandatory
Access	rw
PDO Mapping	No
Value Range	data type specific
Default Value	No

Sub-Index	2h
Description	AI Interrupt upper limit input PV 2
Entry Category	Optional
Access	rw
PDO Mapping	No
Value Range	data type specific
Default Value	No

to

Sub-Index	C7h
Description	AI Interrupt upper limit input PV 199
Entry Category	Optional
Access	rw
PDO Mapping	No
Value Range	data type specific
Default Value	No

7.2.25 Object x138h: AI Tare zero

This object defines the tare-offset value. Net process value is calculated by subtracting the tare-offset value from the process value. It is scaled in physical unit of process value.

OBJECT DESCRIPTION

Index	x138h
Name	AI Tare zero
Object Code	ARRAY
Data Type	Float, Integer16, Integer24, Integer32
Category	Optional

ENTRY DESCRIPTION

Sub-Index	0h
Description	number of entries
Entry Category	Mandatory
Access	ro
PDO Mapping	No
Value Range	1 - C7h
Default Value	No

Sub-Index	1h
Description	AI Tare zero 1
Entry Category	Mandatory
Access	rw
PDO Mapping	No
Value Range	data type specific
Default Value	0

Sub-Index	2h
Description	AI Tare zero 2
Entry Category	Optional
Access	rw
PDO Mapping	No
Value Range	data type specific
Default Value	0

to

Sub-Index	C7h
Description	AI Tare zero 199
Entry Category	Optional
Access	rw
PDO Mapping	No
Value Range	data type specific
Default Value	0

7.2.26 Object 6139h: AI Autotare

Writing a signature value of „tara“ to this object causes a modification of the AI Tare Zero in such a way that the actual AI Net PV becomes zero. This cycle is processed one time.

Signature	MSB			LSB
ASCII	a	r	a	t
hex	61	72	61	74

OBJECT DESCRIPTION

Index	6139h
Name	AI Autotare
Object Code	ARRAY
Data Type	Unsigned32
Category	Optional

ENTRY DESCRIPTION

Sub-Index	0h
Description	number of entries
Entry Category	Mandatory
Access	ro
PDO Mapping	No
Value Range	1 - C7h
Default Value	No

Sub-Index	1h
Description	AI Autotare 1
Entry Category	Mandatory
Access	wo
PDO Mapping	No
Value Range	Unsigned32
Default Value	No

Sub-Index	2h
Description	AI Autotare 2
Entry Category	Optional
Access	wo
PDO Mapping	No
Value Range	Unsigned32
Default Value	No

to

Sub-Index	C7h
Description	AI Autotare 199
Entry Category	Optional
Access	wo
PDO Mapping	No
Value Range	Unsigned32
Default Value	No

7.2.27 Object x140h: AI Net PV

This read only object represents the result of the tare function block and gives the net measured quantity scaled in the physical unit of process values (e.g. degrees centigrade, kg, kN, mm etc.).

OBJECT DESCRIPTION

Index	x140h
Name	AI Net PV
Object Code	ARRAY
Data Type	Float, Integer16, Integer24, Integer32
Category	Optional

ENTRY DESCRIPTION

Sub-Index	0h
Description	number of entries
Entry Category	Mandatory
Access	ro
PDO Mapping	No
Value Range	1 - C7h
Default Value	No

Sub-Index	1h
Description	AI Net PV 1
Entry Category	Mandatory
Access	ro
PDO Mapping	Possible
Value Range	data type specific
Default Value	No

Sub-Index	2h
Description	AI Net PV 2
Entry Category	Optional
Access	ro
PDO Mapping	Possible
Value Range	data type specific
Default Value	No

to

Sub-Index	C7h
Description	AI Net PV 199
Entry Category	Optional
Access	ro
PDO Mapping	Possible
Value Range	data type specific
Default Value	No

7.2.28 Object x143h: AI Interrupt delta net PV

When Net Process Value is mapped to a transmit PDO and its value has changed delta or more since the last PDO transmission then the PDO is transmitted again. A delta value of 0 means, that this function is disabled.

OBJECT DESCRIPTION

Index	x143h
Name	AI Interrupt delta net PV
Object Code	ARRAY
Data Type	Float, Integer16, Integer24, Integer32
Category	Optional

ENTRY DESCRIPTION

Sub-Index	0h
Description	number of entries
Entry Category	Mandatory
Access	ro
PDO Mapping	No
Value Range	1 - C7h
Default Value	No

Sub-Index	1h
Description	AI Interrupt delta net PV 1
Entry Category	Mandatory
Access	rw
PDO Mapping	No
Value Range	data type specific
Default Value	No

Sub-Index	2h
Description	AI Interrupt delta net PV 2
Entry Category	Optional
Access	rw
PDO Mapping	No
Value Range	data type specific
Default Value	No

to

Sub-Index	C7h
Description	AI Interrupt delta net PV 199
Entry Category	Optional
Access	rw
PDO Mapping	No
Value Range	data type specific
Default Value	No

7.2.29 Object x144h: AI Interrupt lower limit net PV

This object sets the lower limits for interrupt-enabled analogue net inputs. The value shall be always left adjusted.

OBJECT DESCRIPTION

Index	x144h
Name	AI Interrupt lower limit net PV
Object Code	ARRAY
Data Type	Float, Integer16, Integer24, Integer32
Category	Optional

ENTRY DESCRIPTION

Sub-Index	0h
Description	number of entries
Entry Category	Mandatory
Access	ro
PDO Mapping	No
Value Range	1 - C7h
Default Value	No

Sub-Index	1h
Description	AI Interrupt lower limit net PV 1
Entry Category	Mandatory
Access	rw
PDO Mapping	No
Value Range	data type specific
Default Value	No

Sub-Index	2h
Description	AI Interrupt lower limit net PV 2
Entry Category	Optional
Access	rw
PDO Mapping	No
Value Range	data type specific
Default Value	No

to

Sub-Index	C7h
Description	AI Interrupt lower limit net PV 199
Entry Category	Optional
Access	rw
PDO Mapping	No
Value Range	data type specific
Default Value	No

7.2.30 Object x145h: AI Interrupt upper limit net PV

This object sets the upper limits for interrupt-enabled analogue net inputs. The value shall be always left adjusted.

OBJECT DESCRIPTION

Index	x145h
Name	AI Interrupt upper limit net PV
Object Code	ARRAY
Data Type	Float, Integer16, Integer24, Integer32
Category	Optional

ENTRY DESCRIPTION

Sub-Index	0h
Description	number of entries
Entry Category	Mandatory
Access	ro
PDO Mapping	No
Value Range	1 - C7h
Default Value	No

Sub-Index	1h
Description	AI Interrupt upper limit net PV 1
Entry Category	Mandatory
Access	rw
PDO Mapping	No
Value Range	data type specific
Default Value	No

Sub-Index	2h
Description	AI Interrupt upper limit net PV 2
Entry Category	Optional
Access	rw
PDO Mapping	No
Value Range	data type specific
Default Value	No

to

Sub-Index	C7h
Description	AI Interrupt upper limit net PV 199
Entry Category	Optional
Access	rw
PDO Mapping	No
Value Range	data type specific
Default Value	No

7.2.31 Object x148h: AI Span start

This value specifies the lower limit where process values are expected. Process values, which are lower than this limit, are marked as negative overloaded.

OBJECT DESCRIPTION

Index	x148h
Name	AI Span start
Object Code	ARRAY
Data Type	Float, Integer16, Integer24, Integer32
Category	Optional

ENTRY DESCRIPTION

Sub-Index	0h
Description	number of entries
Entry Category	Mandatory
Access	ro
PDO Mapping	No
Value Range	1 - C7h
Default Value	No

Sub-Index	1h
Description	AI Span start 1
Entry Category	Mandatory
Access	rw
PDO Mapping	No
Value Range	data type specific
Default Value	No

Sub-Index	2h
Description	AI Span start 2
Entry Category	Optional
Access	rw
PDO Mapping	No
Value Range	data type specific
Default Value	No

to

Sub-Index	C7h
Description	AI Span start 199
Entry Category	Optional
Access	rw
PDO Mapping	No
Value Range	data type specific
Default Value	No

7.2.32 Object x149h: AI Span end

This value specifies the upper limit where process values are expected. Process values exceeding this limit are marked as positive overloaded.

OBJECT DESCRIPTION

Index	x149h
Name	AI Span end
Object Code	ARRAY
Data Type	Float, Integer16, Integer24, Integer32
Category	Optional

ENTRY DESCRIPTION

Sub-Index	0h
Description	number of entries
Entry Category	Mandatory
Access	ro
PDO Mapping	No
Value Range	1 - C7h
Default Value	No

Sub-Index	1h
Description	AI Span end 1
Entry Category	Mandatory
Access	rw
PDO Mapping	No
Value Range	data type specific
Default Value	No

Sub-Index	2h
Description	AI Span end 2
Entry Category	Optional
Access	rw
PDO Mapping	No
Value Range	data type specific
Default Value	No

to

Sub-Index	C7h
Description	AI Span end 199
Entry Category	Optional
Access	rw
PDO Mapping	No
Value Range	data type specific
Default Value	No

7.2.33 Object 6150h: AI Status

This read-only object reflects the status of the analogue input channels.

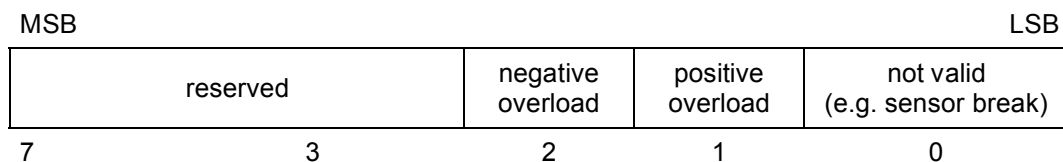

The combination of bit 1 and bit 2 has not to be possible.

For example:

Value	Meaning
00h	No failure at analogue input
03h	Positive overload, eg.g. Pt100 sensor break

OBJECT DESCRIPTION

Index	6150h
Name	AI Status
Object Code	ARRAY
Data Type	Unsigned8
Category	Optional

ENTRY DESCRIPTION

Sub-Index	0h
Description	number of entries
Entry Category	Mandatory
Access	ro
PDO Mapping	No
Value Range	1 - C7h
Default Value	No

Sub-Index	1h
Description	AI Status 1
Entry Category	Mandatory
Access	ro
PDO Mapping	Possible
Value Range	Unsigned8
Default Value	No

Sub-Index	2h
Description	AI Status 2
Entry Category	Optional
Access	ro
PDO Mapping	Possible
Value Range	Unsigned8
Default Value	No

to

Sub-Index	C7h
Description	AI Status 199
Entry Category	Optional
Access	ro
PDO Mapping	Possible
Value Range	Unsigned8
Default Value	No

7.2.34 Object 6160h: AI Control byte

This write-only object starts several control functions of the analogue input function block

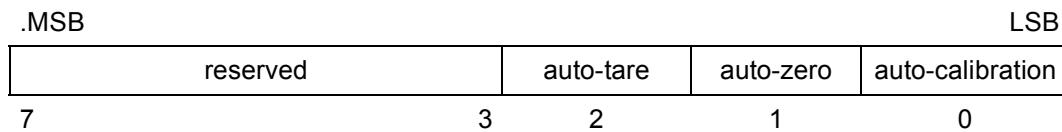

For example:

Value	Meaning
00h	Access to the control byte object is not possible
03h	Allow auto-calibration and auto-zero

OBJECT DESCRIPTION

Index	6160h
Name	AI Control byte
Object Code	ARRAY
Data Type	Unsigned8
Category	Optional

ENTRY DESCRIPTION

Sub-Index	0h
Description	number of entries
Entry Category	Mandatory
Access	ro
PDO Mapping	No
Value Range	1 - C7h
Default Value	No

Sub-Index	1h
Description	AI Control byte 1
Entry Category	Mandatory
Access	wo
PDO Mapping	Possible
Value Range	Unsigned8
Default Value	No

Sub-Index	2h
Description	AI Control byte 2
Entry Category	Optional
Access	wo
PDO Mapping	Possible
Value Range	Unsigned8
Default Value	No

to

Sub-Index	C7h
Description	AI Control byte 199
Entry Category	Optional
Access	wo
PDO Mapping	Possible
Value Range	Unsigned8
Default Value	No

7.2.35 Object 6161h: AI Control byte enable

Bit mask to enable the single bits in object 6160h (AI Control byte enable).

0 – disabled function

1 – enabled function

OBJECT DESCRIPTION

Index	6161h
Name	AI Control byte enable
Object Code	ARRAY
Data Type	Unsigned8
Category	Optional

ENTRY DESCRIPTION

Sub-Index	0h
Description	number of entries
Entry Category	Mandatory
Access	ro
PDO Mapping	No
Value Range	1 - C7h
Default Value	No

Sub-Index	1h
Description	AI Control byte enable 1
Entry Category	Mandatory
Access	rw
PDO Mapping	No
Value Range	Unsigned8
Default Value	0

Sub-Index	2h
Description	AI Control byte enable 2
Entry Category	Optional
Access	rw
PDO Mapping	No
Value Range	Unsigned8
Default Value	0

to

Sub-Index	C7h
Description	AI Control byte enable 199
Entry Category	Optional
Access	rw
PDO Mapping	No
Value Range	Unsigned8
Default Value	0

7.2.36 Object 61A0h: AI Filter type

The object shall define the type of filter to be used for calculation.

Value	Description
0	No filter
1	Moving average
2	Repeating average
3 .. 99	reserved
100 .. 255	Manufacturer specific

- **Calculation of moving average**

There has to be calculated the difference between the current value derived from the A/D converter and the previous calculated average value, This current calculated difference has to be divided by a filter constant (see object 61A1h) and added to the previous calculated sum.

$$Value_N = Value_{N-1} + \frac{Input - Value_{N-1}}{Filterconstant}$$

- **Calculation of repeating average**

At any reading of the current value from the A/D converter the value has to be added to the sum. At any N-th reading (depending on the value of object 61A1h) the sum will be divided by N. Following the value will be set to zero for the next calculation.

$$Value = \frac{\sum_{n=1}^N Input_n}{N}$$

OBJECT DESCRIPTION

Index	61A0h
Name	AI Filter type
Object Code	ARRAY
Data Type	Unsigned8
Category	Optional

ENTRY DESCRIPTION

Sub-Index	0h
Description	number of entries
Entry Category	Mandatory
Access	ro
PDO Mapping	No
Value Range	1 - C7h
Default Value	No

Sub-Index	1h
Description	AI Filter type 1
Entry Category	Mandatory
Access	rw
PDO Mapping	No
Value Range	Unsigned8
Default Value	0

Sub-Index	2h
Description	AI Filter type 2
Entry Category	Optional
Access	rw
PDO Mapping	No
Value Range	Unsigned8
Default Value	0

to

Sub-Index	C7h
Description	AI Filter type 199
Entry Category	Optional
Access	rw
PDO Mapping	No
Value Range	Unsigned8
Default Value	0

7.2.37 Object 61A1h: AI Filter constant

Defines the number of steps used for the filter calculation (see Object 61A0h: AI Filter type).

OBJECT DESCRIPTION

Index	61A1h
Name	AI Filter constant
Object Code	ARRAY
Data Type	Unsigned8
Category	Optional

ENTRY DESCRIPTION

Sub-Index	0h
Description	number of entries
Entry Category	Mandatory
Access	ro
PDO Mapping	No
Value Range	1 - C7h
Default Value	No

Sub-Index	1h
Description	AI Filter constant 1
Entry Category	Mandatory
Access	rw
PDO Mapping	No
Value Range	Unsigned8
Default Value	0

Sub-Index	2h
Description	AI Filter constant 2
Entry Category	Optional
Access	rw
PDO Mapping	No
Value Range	Unsigned8
Default Value	0

to

Sub-Index	C7h
Description	AI Filter constant 199
Entry Category	Optional
Access	rw
PDO Mapping	No
Value Range	Unsigned8
Default Value	0

7.2.38 Object 6200h: DO Write state 8 output lines

This object shall set a group of 8 output lines as a byte of information. A maximum of 199 x 8-bit output blocks is addressable.

OBJECT DESCRIPTION

Index	6200h
Name	DO Write state 8 output lines
Object Code	ARRAY
Data Type	Unsigned8
Category	Conditional

ENTRY DESCRIPTION

Sub-Index	0h
Description	number of entries
Entry Category	Mandatory
Access	ro
PDO Mapping	No
Value Range	1 - C7h
Default Value	No

Sub-Index	1h
Description	DO Write state 8 output lines 1
Entry Category	Mandatory
Access	rw
PDO Mapping	Possible
Value Range	Unsigned8
Default Value	0

Sub-Index	2h
Description	DO Write state 8 output lines 2
Entry Category	Optional
Access	rw
PDO Mapping	Possible
Value Range	Unsigned8
Default Value	0

to

Sub-Index	C7h
Description	DO Write state 8 output lines 199
Entry Category	Optional
Access	rw
PDO Mapping	Possible
Value Range	Unsigned8
Default Value	0

7.2.39 Object 6202h: DO Polarity 8 output lines

This object shall define the polarity of a group of 8 output lines. Output polarity can be inverted individually.

0 – output not inverted 1 – output inverted

If the object is not supported the device behaves accordingly to the default value.

OBJECT DESCRIPTION

Index	6202h
Name	DO Polarity 8 output lines
Object Code	ARRAY
Data Type	Unsigned8
Category	Optional

ENTRY DESCRIPTION

Sub-Index	0h
Description	number of entries
Entry Category	Mandatory
Access	ro
PDO Mapping	No
Value Range	1 - C7h
Default Value	No

Sub-Index	1h
Description	DO Polarity 8 output lines 1
Entry Category	Mandatory
Access	rw
PDO Mapping	No
Value Range	Unsigned8
Default Value	0

Sub-Index	2h
Description	DO Polarity 8 output lines 2
Entry Category	Optional
Access	rw
PDO Mapping	No
Value Range	Unsigned8
Default Value	0

to

Sub-Index	C7h
Description	DO Polarity 8 output lines 199
Entry Category	Optional
Access	rw
PDO Mapping	No
Value Range	Unsigned8
Default Value	0

7.2.40 Object 6206h: DO Fault mode 8 output lines

Defines the fault mode of a group of 8 output lines (1 bit per line).

0 – output value shall be kept if an fault occurs

1 – output value shall take the pre-defined condition specified in Object 6207h: DO Fault state 8 output lines

OBJECT DESCRIPTION

Index	6206h
Name	DO Fault mode 8 output lines
Object Code	ARRAY
Data Type	Unsigned8
Category	Optional

ENTRY DESCRIPTION

Sub-Index	0h
Description	number of entries
Entry Category	Mandatory
Access	ro
PDO Mapping	No
Value Range	1 - C7h
Default Value	No

Sub-Index	1h
Description	DO Fault mode 8 output lines 1
Entry Category	Mandatory
Access	rw
PDO Mapping	No
Value Range	Unsigned8
Default Value	FFh

Sub-Index	2h
Description	DO Fault mode 8 output lines 2
Entry Category	Optional
Access	rw
PDO Mapping	No
Value Range	Unsigned8
Default Value	FFh

to

Sub-Index	C7h
Description	DO Fault mode 8 output lines 199
Entry Category	Optional
Access	rw
PDO Mapping	No
Value Range	Unsigned8
Default Value	FFh

7.2.41 Object 6207h: DO Fault state 8 output lines

Defines the pre-defined state on detecting a fault condition. Defined for a group of 8 output lines. The corresponding bit must be set in the default output line mode (see Object 6206h: DO Fault mode 8 output lines).

- 0 – output is set to '0' in case of fault, if Object 6206h: DO Fault mode 8 output lines is enabled
- 1 – output is set to '1' in case of fault, if Object 6206h: DO Fault mode 8 output lines is enabled

OBJECT DESCRIPTION

Index	6207h
Name	DO Fault state 8 output lines
Object Code	ARRAY
Data Type	Unsigned8
Category	Optional

ENTRY DESCRIPTION

Sub-Index	0h
Description	number of entries
Entry Category	Mandatory
Access	ro
PDO Mapping	No
Value Range	1 - C7h
Default Value	No

Sub-Index	1h
Description	DO Fault state 8 output lines 1
Entry Category	Mandatory
Access	rw
PDO Mapping	No
Value Range	Unsigned8
Default Value	0

Sub-Index	2h
Description	DO Fault state 8 output lines 2
Entry Category	Optional
Access	rw
PDO Mapping	No
Value Range	Unsigned8
Default Value	0

to

Sub-Index	C7h
Description	DO Fault state 8 output lines 199
Entry Category	Optional
Access	rw
PDO Mapping	No
Value Range	Unsigned8
Default Value	0

7.2.42 Object 6210h: DO Link object 8 output lines

This object describes the source for the DO Write state 8 output lines if it lies within another functional block of the same device. The object defined by index and sub-index is directly linked to the DO Write state 8 output lines.

OBJECT DESCRIPTION

Index	6210h
Name	DO Link object 8 output lines
Object Code	RECORD
Data Type	PDOmapping
Category	Optional

ENTRY DESCRIPTION

Sub-Index	0h
Description	number of entries
Entry Category	Mandatory
Access	ro
PDO Mapping	No
Value Range	1 - C7h
Default Value	No

Sub-Index	1h
Description	DO Link object 8 output lines 1
Entry Category	Mandatory
Access	rw
PDO Mapping	No
Value Range	Unsigned32
Default Value	No

Sub-Index	2h
Description	DO Link object 8 output lines 2
Entry Category	Optional
Access	rw
PDO Mapping	No
Value Range	Unsigned32
Default Value	No

to

Sub-Index	C7h
Description	DO Link object 8 output lines 199
Entry Category	Optional
Access	rw
PDO Mapping	No
Value Range	Unsigned32
Default Value	No

7.2.43 Object 6220h: DO Write state 1 output lines

This object shall set single output lines information. A maximum of 199 outputs is addressable at this index.

OBJECT DESCRIPTION

Index	6220h
Name	DO Write state 1 output lines
Object Code	ARRAY
Data Type	Boolean
Category	Optional

ENTRY DESCRIPTION

Sub-Index	0h
Description	number of entries
Entry Category	Mandatory
Access	ro
PDO Mapping	No
Value Range	1 - C7h
Default Value	No

Sub-Index	1h
Description	DO Write state 1 output lines 1
Entry Category	Mandatory
Access	rw
PDO Mapping	Possible
Value Range	Boolean
Default Value	0

Sub-Index	2h
Description	DO Write state 1 output lines 2
Entry Category	Optional
Access	rw
PDO Mapping	Possible
Value Range	Boolean
Default Value	0

to

Sub-Index	C7h
Description	DO Write state 1 output lines 199
Entry Category	Optional
Access	rw
PDO Mapping	Possible
Value Range	Boolean
Default Value	0

7.2.44 Object 6240h: DO Polarity 1 output lines

This object shall set the polarity of single output lines. A maximum of 199 outputs is addressable at this index.

0 – output inverted

1 – output not inverted

If this object is not supported the device shall behave accordingly to the default value.

OBJECT DESCRIPTION

Index	6240h
Name	DO Polarity 1 output lines
Object Code	ARRAY
Data Type	Boolean
Category	Optional

ENTRY DESCRIPTION

Sub-Index	0h
Description	number of entries
Entry Category	Mandatory
Access	ro
PDO Mapping	No
Value Range	1 - C7h
Default Value	No

Sub-Index	1h
Description	DO Polarity 1 output lines 1
Entry Category	Mandatory
Access	rw
PDO Mapping	No
Value Range	Boolean
Default Value	0

Sub-Index	2h
Description	DO Polarity 1 output lines 2
Entry Category	Optional
Access	rw
PDO Mapping	No
Value Range	Boolean
Default Value	0

to

Sub-Index	C7h
Description	DO Polarity 1 output lines 199
Entry Category	Optional
Access	rw
PDO Mapping	No
Value Range	Boolean
Default Value	0

7.2.45 Object 6250h: DO Fault mode 1 output lines

Sets the fault mode of a single output line. This defines the default output mode on detecting a fault condition.

0 – output value shall be kept if a fault occurs

1 – output value shall take the pre-defined condition as specified in Object 6260h: DO Fault state 1 output lines

OBJECT DESCRIPTION

Index	6250h
Name	DO Fault mode 1 output lines
Object Code	ARRAY
Data Type	Boolean
Category	Optional

ENTRY DESCRIPTION

Sub-Index	0h
Description	number of entries
Entry Category	Mandatory
Access	ro
PDO Mapping	No
Value Range	1 - C7h
Default Value	No

Sub-Index	1h
Description	DO Fault mode 1 output lines 1
Entry Category	Mandatory
Access	rw
PDO Mapping	No
Value Range	Boolean
Default Value	True

Sub-Index	2h
Description	DO Fault mode 1 output lines 2
Entry Category	Optional
Access	rw
PDO Mapping	No
Value Range	Boolean
Default Value	True

to

Sub-Index	C7h
Description	DO Fault mode 1 output lines 199
Entry Category	Optional
Access	rw
PDO Mapping	No
Value Range	Boolean
Default Value	True

7.2.46 Object 6260h: DO Fault state 1 output lines

Output line fault state. This defines the pre-defined output state on detecting a fault condition. The corresponding bit must be set in the default output line mode (see Object 6250h: DO Fault mode 1 output lines).

- 0 – output shall be set to '0' in case of fault, if the corresponding Object 6250h: DO Fault mode 1 output lines is enabled
- 1 – output shall be set to '1' in case of fault, if the corresponding Object 6250h: DO Fault mode 1 output lines is enabled

OBJECT DESCRIPTION

Index	6260h
Name	DO Fault state 1 output lines
Object Code	ARRAY
Data Type	Boolean
Category	Optional

ENTRY DESCRIPTION

Sub-Index	0h
Description	number of entries
Entry Category	Mandatory
Access	ro
PDO Mapping	No
Value Range	1 - C7h
Default Value	No

Sub-Index	1h
Description	DO Fault state 1 output lines 1
Entry Category	Mandatory
Access	rw
PDO Mapping	No
Value Range	Boolean
Default Value	0

Sub-Index	2h
Description	DO Fault state 1 output lines 2
Entry Category	Optional
Access	rw
PDO Mapping	No
Value Range	Boolean
Default Value	0

to

Sub-Index	C7h
Description	DO Fault state 1 output lines 199
Entry Category	Optional
Access	rw
PDO Mapping	No
Value Range	Boolean
Default Value	0

7.2.47 Object 6280h: DO Link object 1 output lines

This object describes the source for the DO Write state 1 output lines if it lies within another functional block of the same device. The object defined by index and Sub-Index is directly linked to the DO Write state 1 output lines.

OBJECT DESCRIPTION

Index	6280h
Name	DO Link object 1 output lines
Object Code	RECORD
Data Type	PDOmapping
Category	Optional

ENTRY DESCRIPTION

Sub-Index	0h
Description	number of entries
Entry Category	Mandatory
Access	ro
PDO Mapping	No
Value Range	1 – C7h
Default Value	No

Sub-Index	1h
Description	DO Link object 1 output lines 1
Entry Category	Mandatory
Access	rw
PDO Mapping	No
Value Range	Unsigned32
Default Value	No

Sub-Index	2h
Description	DO Link object 1 output lines 2
Entry Category	Optional
Access	rw
PDO Mapping	No
Value Range	Unsigned32
Default Value	No

to

Sub-Index	C7h
Description	DO Link object 1 output lines 199
Entry Category	Optional
Access	rw
PDO Mapping	No
Value Range	Unsigned32
Default Value	No

7.2.48 Object x300h: AO Output PV

This object represents the process value, which is the input to the analogue output function block. It is scaled in the physical unit of process values (e.g. degrees centigrade, kg, kN, mm etc.).

OBJECT DESCRIPTION

Index	x300h
Name	AO Output PV
Object Code	ARRAY
Data Type	Float, Integer16, Integer24, Integer32
Category	Conditional

ENTRY DESCRIPTION

Sub-Index	0h
Description	number of entries
Entry Category	Mandatory
Access	ro
PDO Mapping	No
Value Range	1 - C7h
Default Value	No

Sub-Index	1h
Description	AO Output PV 1
Entry Category	Mandatory
Access	rw
PDO Mapping	Possible
Value Range	data type specific
Default Value	0

Sub-Index	2h
Description	AO Output PV 2
Entry Category	Optional
Access	rw
PDO Mapping	Possible
Value Range	data type specific
Default Value	0

to

Sub-Index	C7h
Description	AO Output PV 199
Entry Category	Optional
Access	rw
PDO Mapping	Possible
Value Range	data type specific
Default Value	0

7.2.49 Object 6301h: AO Physical unit PV

This object describes the physical unit for the process values within the analogue output function block (see Object 6131h: AI Physical unit PV).

OBJECT DESCRIPTION

Index	6301h
Name	AO Physical unit PV
Object Code	ARRAY
Data Type	Unsigned32
Category	Optional

ENTRY DESCRIPTION

Sub-Index	0h
Description	number of entries
Entry Category	Mandatory
Access	ro
PDO Mapping	No
Value Range	1 - C7h
Default Value	No

Sub-Index	1h
Description	AO Physical unit PV 1
Entry Category	Mandatory
Access	rw
PDO Mapping	No
Value Range	Unsigned16
Default Value	No

Sub-Index	2h
Description	AO Physical unit PV 2
Entry Category	Optional
Access	rw
PDO Mapping	No
Value Range	Unsigned16
Default Value	No

to

Sub-Index	C7h
Description	AO Physical unit PV 199
Entry Category	Optional
Access	rw
PDO Mapping	No
Value Range	Unsigned16
Default Value	No

7.2.50 Object 6302h: AO Decimal digits PV

This object describes the number of decimal digits following the decimal point for interpretation of data types Integer8, Integer16 and Integer32.

Example: A field value of 1.230 (Float) will be coded as 123 in Integer16 format if number of decimal digits is set to 2.

OBJECT DESCRIPTION

Index	6302h
Name	AO Decimal digits PV
Object Code	ARRAY
Data Type	Unsigned8
Category	Optional

ENTRY DESCRIPTION

Sub-Index	0h
Description	number of entries
Entry Category	Mandatory
Access	ro
PDO Mapping	No
Value Range	1 - C7h
Default Value	No

Sub-Index	1h
Description	AO Decimal digits PV 1
Entry Category	Mandatory
Access	rw
PDO Mapping	No
Value Range	0 – 9h
Default Value	No

Sub-Index	2h
Description	AO Decimal digits PV 2
Entry Category	Optional
Access	rw
PDO Mapping	No
Value Range	0 – 9h
Default Value	No

to

Sub-Index	C7h
Description	AO Decimal digits PV 199
Entry Category	Optional
Access	rw
PDO Mapping	No
Value Range	0 – 9h
Default Value	No

7.2.51 Object 6303h: AO Link output PV

This object describes the source for the AO Output PV if it lies within another functional block of the same device. The object defined by index and sub-index is directly linked to the AO Output PV.

OBJECT DESCRIPTION

Index	6303h
Name	AO Link output PV
Object Code	RECORD
Data Type	PDOmapping
Category	Optional

ENTRY DESCRIPTION

Sub-Index	0h
Description	number of entries
Entry Category	Mandatory
Access	ro
PDO Mapping	No
Value Range	1 - 199
Default Value	No

Sub-Index	1h
Description	AO Link output PV 1
Entry Category	Mandatory
Access	rw
PDO Mapping	No
Value Range	Unsigned32
Default Value	No

Sub-Index	2h
Description	AO Link output PV 2
Entry Category	Optional
Access	rw
PDO Mapping	No
Value Range	Unsigned32
Default Value	No

to

Sub-Index	C7h
Description	AO Link output PV 199
Entry Category	Optional
Access	rw
PDO Mapping	No
Value Range	Unsigned32
Default Value	No

7.2.52 Object 6310h: AO Output type

This object specifies the type of the analogue output.

Value	Meaning
0 .. 9	reserved
10	Voltage
11	+/-10V
12 .. 19	reserved
20	Current
21	4..20mA
22	+/-20mA
23 .. 29	reserved
30	Frequency
31 .. 39	reserved
40	PWM
41 ... 999	reserved
1000 .. 65535	manufacturer specific

OBJECT DESCRIPTION

Index	6310h
Name	AO Output type
Object Code	ARRAY
Data Type	Unsigned16
Category	Optional

ENTRY DESCRIPTION

Sub-Index	0h
Description	number of entries
Entry Category	Mandatory
Access	ro
PDO Mapping	No
Value Range	1 - C7h
Default Value	No

Sub-Index	1h
Description	AO Output type 1
Entry Category	Mandatory
Access	rw
PDO Mapping	No
Value Range	Unsigned16
Default Value	No

Sub-Index	2h
Description	AO Output type 2
Entry Category	Optional
Access	rw
PDO Mapping	No
Value Range	Unsigned16
Default Value	No

to

Sub-Index	C7h
Description	AO Output type 199
Entry Category	Optional
Access	rw
PDO Mapping	No
Value Range	Unsigned16
Default Value	No

7.2.53 Object x320h: AO Output scaling 1 PV

This object defines the process value of the first calibration point for the analogue output channel. It is scaled in physical unit of process value.

OBJECT DESCRIPTION

Index	x320h
Name	AO Output scaling 1 PV
Object Code	ARRAY
Data Type	Float, Integer16, Integer24, Integer32
Category	Optional

ENTRY DESCRIPTION

Sub-Index	0h
Description	number of entries
Entry Category	Mandatory
Access	ro
PDO Mapping	No
Value Range	1 - C7h
Default Value	No

Sub-Index	1h
Description	AO Output scaling 1 PV 1
Entry Category	Mandatory
Access	rw
PDO Mapping	No
Value Range	data type specific
Default Value	No

Sub-Index	2h
Description	AO Output scaling 1 PV 2
Entry Category	Optional
Access	rw
PDO Mapping	No
Value Range	data type specific
Default Value	No

to

Sub-Index	C7h
Description	AO Output scaling 1 PV 199
Entry Category	Optional
Access	rw
PDO Mapping	No
Value Range	data type specific
Default Value	No

7.2.54 Object x321h: AO Output scaling 1 FV

This object defines the field value of the first calibration point for the analogue output channel. It is scaled in physical unit of field value.

OBJECT DESCRIPTION

Index	x321h
Name	AO Output scaling 1 FV
Object Code	ARRAY
Data Type	Float, Integer16, Integer24, Integer32
Category	Optional

ENTRY DESCRIPTION

Sub-Index	0h
Description	number of entries
Entry Category	Mandatory
Access	ro
PDO Mapping	No
Value Range	1 - C7h
Default Value	No

Sub-Index	1h
Description	AO Output scaling 1 FV 1
Entry Category	Mandatory
Access	rw
PDO Mapping	No
Value Range	data type specific
Default Value	No

Sub-Index	2h
Description	AO Output scaling 1 FV 2
Entry Category	Optional
Access	rw
PDO Mapping	No
Value Range	data type specific
Default Value	No

to

Sub-Index	C7h
Description	AO Output scaling 1 FV 199
Entry Category	Optional
Access	rw
PDO Mapping	No
Value Range	data type specific
Default Value	No

7.2.55 Object x322h: AO Output scaling 2 PV

This object defines the process value of the second calibration point for the analogue output channel. It is scaled in physical unit of process value.

OBJECT DESCRIPTION

Index	x322h
Name	AO Output scaling 2 PV
Object Code	ARRAY
Data Type	Float, Integer16, Integer24, Integer32
Category	Optional

ENTRY DESCRIPTION

Sub-Index	0h
Description	number of entries
Entry Category	Mandatory
Access	ro
PDO Mapping	No
Value Range	1 - C7h
Default Value	No

Sub-Index	1h
Description	AO Output scaling 2 PV 1
Entry Category	Mandatory
Access	rw
PDO Mapping	No
Value Range	data type specific
Default Value	No

Sub-Index	2h
Description	AO Output scaling 2 PV 2
Entry Category	Optional
Access	rw
PDO Mapping	No
Value Range	data type specific
Default Value	No

to

Sub-Index	C7h
Description	AO Output scaling 2 PV 199
Entry Category	Optional
Access	rw
PDO Mapping	No
Value Range	data type specific
Default Value	No

7.2.56 Object x323h: AO Output scaling 2 FV

This object defines the field value of the second calibration point for the analogue output channel. It is scaled in physical unit of field value.

OBJECT DESCRIPTION

Index	x323h
Name	AO Output scaling 2 FV
Object Code	ARRAY
Data Type	Float, Integer16, Integer24, Integer32
Category	Optional

ENTRY DESCRIPTION

Sub-Index	0h
Description	number of entries
Entry Category	Mandatory
Access	ro
PDO Mapping	No
Value Range	1 - C7h
Default Value	No

Sub-Index	1h
Description	AO Output scaling 2 FV 1
Entry Category	Mandatory
Access	rw
PDO Mapping	No
Value Range	data type specific
Default Value	No

Sub-Index	2h
Description	AO Output scaling 2 FV 2
Entry Category	Optional
Access	rw
PDO Mapping	No
Value Range	data type specific
Default Value	No

to

Sub-Index	C7h
Description	AO Output scaling 2 FV 199
Entry Category	Optional
Access	rw
PDO Mapping	No
Value Range	data type specific
Default Value	No

7.2.57 Object x330h: AO Output FV

This object represents result of the output scaling for the analogue output channel and gives the output quantity scaled in the physical unit of field values (e.g. Volt, mA etc.).

OBJECT DESCRIPTION

Index	x330h
Name	AO Output FV
Object Code	ARRAY
Data Type	Float, Integer16, Integer24, Integer32
Category	Optional

ENTRY DESCRIPTION

Sub-Index	0h
Description	number of entries
Entry Category	Mandatory
Access	ro
PDO Mapping	No
Value Range	1 - C7h
Default Value	No

Sub-Index	1h
Description	AO Output FV 1
Entry Category	Mandatory
Access	rw
PDO Mapping	Possible
Value Range	data type specific
Default Value	No

Sub-Index	2h
Description	AO Output FV 2
Entry Category	Optional
Access	rw
PDO Mapping	Possible
Value Range	data type specific
Default Value	No

to

Sub-Index	C7h
Description	AO Output FV 199
Entry Category	Optional
Access	rw
PDO Mapping	Possible
Value Range	data type specific
Default Value	No

7.2.58 Object 6331h: AO Physical unit FV

This object describes the physical unit for the field values within the analogue output function block (see Object 6131h: AI Physical unit PV).

OBJECT DESCRIPTION

Index	6331h
Name	AO Physical unit FV
Object Code	ARRAY
Data Type	Unsigned32
Category	Optional

ENTRY DESCRIPTION

Sub-Index	0h
Description	number of entries
Entry Category	Mandatory
Access	ro
PDO Mapping	No
Value Range	1 - C7h
Default Value	No

Sub-Index	1h
Description	AO Physical unit FV 1
Entry Category	Mandatory
Access	rw
PDO Mapping	No
Value Range	Unsigned32
Default Value	No

Sub-Index	2h
Description	AO Physical unit FV 2
Entry Category	Optional
Access	rw
PDO Mapping	No
Value Range	Unsigned32
Default Value	No

to

Sub-Index	C7h
Description	AO Physical unit FV 199
Entry Category	Optional
Access	rw
PDO Mapping	No
Value Range	Unsigned32
Default Value	No

7.2.59 Object 6332h: AO Decimal digits FV

This object describes the number of decimal digits following the decimal point for interpretation of data types Integer8, Integer16 and Integer32.

Example: A field value of 1.230 (Float) will be coded as 123 in Integer16 format if number of decimal digits is set to 2.

OBJECT DESCRIPTION

Index	6332h
Name	AO Decimal digits FV
Object Code	ARRAY
Data Type	Unsigned8
Category	Optional

ENTRY DESCRIPTION

Sub-Index	0h
Description	number of entries
Entry Category	Mandatory
Access	ro
PDO Mapping	N
Value Range	1 - C7h
Default Value	No

Sub-Index	1h
Description	AO Decimal digits FV 1
Entry Category	Mandatory
Access	rw
PDO Mapping	No
Value Range	0 – 9h
Default Value	No

Sub-Index	2h
Description	AO Decimal digits FV 2
Entry Category	Optional
Access	rw
PDO Mapping	No
Value Range	0 – 9h
Default Value	No

to

Sub-Index	C7h
Description	AO Decimal digits FV 199
Entry Category	Optional
Access	rw
PDO Mapping	No
Value Range	0 – 9h
Default Value	No

7.2.60 Object 6340h: AO Fault mode

This object defines, whether an output is set to a pre-defined error value (see Object x341h: AO Fault FV) in case of an internal device failure.

- 0 – actual value rest
- 1 – reverts to error value (see Object x341h: AO Fault FV)
- other – reserved

OBJECT DESCRIPTION

Index	6340h
Name	AO Fault mode
Object Code	ARRAY
Data Type	Unsigned8
Category	Optional

ENTRY DESCRIPTION

Sub-Index	0h
Description	number of entries
Entry Category	Mandatory
Access	ro
PDO Mapping	No
Value Range	1 - C7h
Default Value	No

Sub-Index	1h
Description	AO Fault mode 1
Entry Category	Mandatory
Access	rw
PDO Mapping	No
Value Range	0 – 1h
Default Value	1

Sub-Index	2h
Description	AO Fault mode 2
Entry Category	Optional
Access	rw
PDO Mapping	No
Value Range	0 – 1h
Default Value	1

to

Sub-Index	C7h
Description	AO Fault mode 199
Entry Category	Optional
Access	rw
PDO Mapping	No
Value Range	0 – 1h
Default Value	1

7.2.61 Object x341h: AO Fault FV

Field value to be taken as output if there is a fault condition and AO Fault Mode is 1.

OBJECT DESCRIPTION

Index	x341h
Name	AO Fault FV
Object Code	ARRAY
Data Type	Float, Integer16, Integer24, Integer32
Category	Optional

ENTRY DESCRIPTION

Sub-Index	0h
Description	number of entries
Entry Category	Mandatory
Access	ro
PDO Mapping	No
Value Range	1 - C7h
Default Value	No

Sub-Index	1h
Description	AO Fault FV 1
Entry Category	Mandatory
Access	rw
PDO Mapping	No
Value Range	data type specific
Default Value	0

Sub-Index	2h
Description	AO Fault FV 2
Entry Category	Optional
Access	rw
PDO Mapping	No
Value Range	data type specific
Default Value	0

to

Sub-Index	C7h
Description	AO Fault FV 199
Entry Category	Optional
Access	rw
PDO Mapping	No
Value Range	data type specific
Default Value	0

7.2.62 Object x400h: CO Effective Current Value Xeff

This object defines the effective current value used by the control algorithm. The physical unit and the number of decimal digits of this object are defined by objects 6406h and 6407h.

OBJECT DESCRIPTION

Index	x400h
Name	CO Effective Current Value Xeff
Object Code	ARRAY
Data Type	Float, Integer16, Integer24, Integer32
Category	Mandatory

ENTRY DESCRIPTION

Sub-Index	0h
Description	number of entries
Entry Category	Mandatory
Access	ro
PDO Mapping	No
Value Range	1 - C7h
Default Value	No

Sub-Index	1h
Description	CO Effective Current Value 1
Entry Category	Mandatory
Access	rw
PDO Mapping	Possible
Value Range	data type specific
Default Value	No

Sub-Index	2h
Description	CO Effective Current Value 2
Entry Category	Optional
Access	rw
PDO Mapping	Possible
Value Range	data type specific
Default Value	No

to

Sub-Index	C7h
Description	CO Effective Current Value 199
Entry Category	Optional
Access	rw
PDO Mapping	Possible
Value Range	data type specific
Default Value	No

7.2.63 Object x401h: CO Effective Set Point Weff

This object holds the set point currently used by the controller algorithm. In most cases it will be a copy of the objects x402h or x403h (it may be generated by set point ramp also). The physical unit and the number of decimal digits of this object are defined by objects 6406h and 6407h.

OBJECT DESCRIPTION

Index	x401h
Name	CO Effective Set Point Weff
Object Code	ARRAY
Data Type	Float, Integer16, Integer24, Integer32
Category	Mandatory

ENTRY DESCRIPTION

Sub-Index	0h
Description	number of entries
Entry Category	Mandatory
Access	ro
PDO Mapping	No
Value Range	1 – C7h
Default Value	No

Sub-Index	1h
Description	CO Effective Set Point 1
Entry Category	Mandatory
Access	ro
PDO Mapping	Possible
Value Range	data type specific
Default Value	No

Sub-Index	2h
Description	CO Effective Set Point 2
Entry Category	Optional
Access	ro
PDO Mapping	Possible
Value Range	data type specific
Default Value	No

to

Sub-Index	C7h
Description	Effective Set Point Weff 199
Entry Category	Optional
Access	ro
PDO Mapping	Possible
Value Range	data type specific
Default Value	No

7.2.64 Object x402h: CO Set point W

The first set point is variable within the limits of W0 and W100 ($W0 \leq W \leq W100$). The physical unit and the number of decimal digits of this object are defined by objects 6406h and 6407h.

OBJECT DESCRIPTION

Index	x402h
Name	CO Set point W
Object Code	ARRAY
Data Type	Float, Integer16, Integer24, Integer32
Category	Mandatory

ENTRY DESCRIPTION

Sub-Index	0h
Description	number of entries
Entry Category	Mandatory
Access	ro
PDO Mapping	No
Value Range	1 - C7h
Default Value	No

Sub-Index	1h
Description	CO Set point W 1
Entry Category	Mandatory
Access	rw
PDO Mapping	Possible
Value Range	data type specific
Default Value	No

Sub-Index	2h
Description	CO Set point W 2
Entry Category	Optional
Access	rw
PDO Mapping	Possible
Value Range	data type specific
Default Value	No

to

Sub-Index	C7h
Description	CO Set point W 199
Entry Category	Optional
Access	rw
PDO Mapping	Possible
Value Range	data type specific
Default Value	No

7.2.65 Object x403h: CO 2nd Set point W2

The second set point is variable within the limits of W0 and W100 ($W0 \leq W \leq W100$). The physical unit and the number of decimal digits of this object are defined by objects 6406h and 6407h.

OBJECT DESCRIPTION

Index	x403h
Name	CO 2nd Set point W2
Object Code	ARRAY
Data Type	Float, Integer16, Integer24, Integer32
Category	Mandatory

ENTRY DESCRIPTION

Sub-Index	0h
Description	number of entries
Entry Category	Mandatory
Access	ro
PDO Mapping	No
Value Range	1 - C7h
Default Value	No

Sub-Index	1h
Description	CO 2nd Set point 1
Entry Category	Mandatory
Access	rw
PDO Mapping	Possible
Value Range	data type specific
Default Value	No

Sub-Index	2h
Description	CO 2nd Set point 2
Entry Category	Optional
Access	rw
PDO Mapping	Possible
Value Range	data type specific
Default Value	No

to

Sub-Index	C7h
Description	CO 2nd Set point 199
Entry Category	Optional
Access	rw
PDO Mapping	Possible
Value Range	data type specific
Default Value	No

7.2.66 Object x404h: CO Lower Set Point Limit W0

The object describes the lower limit of the set point. The physical unit and the number of decimal digits of this object are defined by objects 6406h and 6407h.

OBJECT DESCRIPTION

Index	x404h
Name	CO Lower Set Point Limit W0
Object Code	ARRAY
Data Type	Float, Integer16, Integer24, Integer32
Category	Optional

ENTRY DESCRIPTION

Sub-Index	0h
Description	number of entries
Entry Category	Mandatory
Access	ro
PDO Mapping	No
Value Range	1 - C7h
Default Value	No

Sub-Index	1h
Description	CO Lower Set Point Limit 1
Entry Category	Mandatory
Access	rw
PDO Mapping	No
Value Range	data type specific
Default Value	No

Sub-Index	2h
Description	CO Lower Set Point Limit 2
Entry Category	Optional
Access	rw
PDO Mapping	No
Value Range	data type specific
Default Value	No

to

Sub-Index	C7h
Description	CO Lower Set Point Limit 199
Entry Category	Optional
Access	rw
PDO Mapping	No
Value Range	data type specific
Default Value	No

7.2.67 Object x405h: CO Upper Set Point Limit W100

The object describes the upper limit of the set point. The physical unit and the number of decimal digits of this object are defined by objects 6406h and 6407h.

OBJECT DESCRIPTION

Index	x405h
Name	CO Upper Set Point Limit W100
Object Code	ARRAY
Data Type	Float, Integer16, Integer24, Integer32
Category	Optional

ENTRY DESCRIPTION

Sub-Index	0h
Description	number of entries
Entry Category	Mandatory
Access	ro
PDO Mapping	No
Value Range	1 - C7h
Default Value	No

Sub-Index	1h
Description	CO Upper Set Point Limit 1
Entry Category	Mandatory
Access	rw
PDO Mapping	No
Value Range	data type specific
Default Value	No

Sub-Index	2h
Description	CO Upper Set Point Limit 2
Entry Category	Optional
Access	rw
PDO Mapping	No
Value Range	data type specific
Default Value	No

to

Sub-Index	C7h
Description	CO Upper Set Point Limit 199
Entry Category	Optional
Access	rw
PDO Mapping	No
Value Range	data type specific
Default Value	No

7.2.68 Object 6406h: CO Physical Unit Current Value / Set Point

The object describes the physical unit of the objects beginning from x400h to x405h (see Object 6131h: AI Physical unit PV).

OBJECT DESCRIPTION

Index	6406h
Name	CO Physical Unit XW
Object Code	ARRAY
Data Type	Unsigned32
Category	Mandatory

ENTRY DESCRIPTION

Sub-Index	0h
Description	number of entries
Entry Category	Mandatory
Access	ro
PDO Mapping	No
Value Range	1 - C7h
Default Value	No

Sub-Index	1h
Description	CO Physical Unit XW 1
Entry Category	Mandatory
Access	rw
PDO Mapping	No
Value Range	Unsigned32
Default Value	No

Sub-Index	2h
Description	CO Physical Unit XW 2
Entry Category	Optional
Access	rw
PDO Mapping	No
Value Range	Unsigned32
Default Value	No

to

Sub-Index	C7h
Description	CO Physical Unit XW 199
Entry Category	Optional
Access	rw
PDO Mapping	No
Value Range	Unsigned32
Default Value	No

7.2.69 Object 6407h: CO Decimal Digits Current Value / Set Point

The object describes the number of decimal digits of the objects beginning from x400h to x405h.

OBJECT DESCRIPTION

Index	6407h
Name	CO Decimal Digits XW
Object Code	ARRAY
Data Type	Unsigned8
Category	Mandatory

ENTRY DESCRIPTION

Sub-Index	0h
Description	number of entries
Entry Category	Mandatory
Access	ro
PDO Mapping	No
Value Range	1 - C7h
Default Value	No

Sub-Index	1h
Description	CO Decimal Digits XW 1
Entry Category	Mandatory
Access	rw
PDO Mapping	No
Value Range	0 - 15
Default Value	No

Sub-Index	2h
Description	CO Decimal Digits XW 2
Entry Category	Optional
Access	rw
PDO Mapping	No
Value Range	0 - 15
Default Value	No

to

Sub-Index	C7h
Description	CO Decimal Digits XW 199
Entry Category	Optional
Access	rw
PDO Mapping	No
Value Range	0 - 15
Default Value	No

7.2.70 Object 6410h: CO Effective Controller Output Y

This object holds effective controller output calculated by the PID algorithm. The object is read only. The value is given in percent with one decimal digit after the comma. The value will always be within the range of Ymin and Ymax ($Y_{min} \leq Y \leq Y_{max}$).

hexadecimal value	decimal value	percent value
FC18h	-1000	-100.0 %
.....
FE0Ch	-500	-50.0 %
.....
0000h	0	0.0 %
.....
01F4h	500	50.0 %
.....
03E8h	1000	100.0 %

OBJECT DESCRIPTION

Index	6410h
Name	CO Effective Controller Output Y
Object Code	ARRAY
Data Type	Unsigned16
Category	Mandatory

ENTRY DESCRIPTION

Sub-Index	0h
Description	number of entries
Entry Category	Mandatory
Access	ro
PDO Mapping	No
Value Range	1 - C7h
Default Value	No

Sub-Index	1h
Description	CO Effective Controller Output 1
Entry Category	Mandatory
Access	ro
PDO Mapping	Possible
Value Range	0000h – 03E8h, FC18h - FFFFh
Default Value	No

Sub-Index	2h
Description	CO Effective Controller Output 2
Entry Category	Optional
Access	ro
PDO Mapping	Possible
Value Range	0000h – 03E8h, FC18h - FFFFh
Default Value	No

to

Sub-Index	C7h
Description	CO Effective Controller Output 199
Entry Category	Optional
Access	ro
PDO Mapping	Possible
Value Range	0000h – 03E8h, FC18h - FFFFh
Default Value	No

7.2.71 Object 6411h: CO Differential Controller Output Ydiff

This object holds differential controller output calculated by the PID algorithm. The object is read only. The value is given in percent with one decimal digit after the comma (see Object 6410h: CO Effective Controller Output Y). The value will always be within the range of Ymin and Ymax ($Y_{diff} < (Y_{max} - Y_{min})$).

OBJECT DESCRIPTION

Index	6411j
Name	Differential Controller Output Ydiff
Object Code	ARRAY
Data Type	Unsigned16
Category	Optional

ENTRY DESCRIPTION

Sub-Index	0h
Description	number of entries
Entry Category	Mandatory
Access	ro
PDO Mapping	No
Value Range	1 - C7h
Default Value	No

Sub-Index	1h
Description	CO Differential Controller Output 1
Entry Category	Mandatory
Access	ro
PDO Mapping	Possible
Value Range	0000h – 03E8h, FC18h - FFFFh
Default Value	No

Sub-Index	2h
Description	CO Differential Controller Output 2
Entry Category	Optional
Access	ro
PDO Mapping	Possible
Value Range	0000h – 03E8h, FC18h - FFFFh
Default Value	No

to

Sub-Index	C7h
Description	CO Differential Controller Output 199
Entry Category	Optional
Access	ro
PDO Mapping	Possible
Value Range	0000h – 03E8h, FC18h - FFFFh
Default Value	No

7.2.72 Object 6412h: CO Manual Controller Output

The value is used as output in the manual controller mode. The value is given in percent with one decimal digit after the comma (see Object 6410h: CO Effective Controller Output Y).

OBJECT DESCRIPTION

Index	6412h
Name	Manual Controller Output
Object Code	ARRAY
Data Type	Unsigned16
Category	Optional

ENTRY DESCRIPTION

Sub-Index	0h
Description	number of entries
Entry Category	Mandatory
Access	ro
PDO Mapping	No
Value Range	1 - C7h
Default Value	No

Sub-Index	1h
Description	Manual Controller Output 1
Entry Category	Mandatory
Access	rw
PDO Mapping	Possible
Value Range	0000h – 03E8h, FC18h - FFFFh
Default Value	0

Sub-Index	2h
Description	Manual Controller Output 2
Entry Category	Optional
Access	rw
PDO Mapping	Possible
Value Range	0000h – 03E8h, FC18h - FFFFh
Default Value	0

to

Sub-Index	C7h
Description	Manual Controller Output 199
Entry Category	Optional
Access	rw
PDO Mapping	Possible
Value Range	0000h – 03E8h, FC18h - FFFFh
Default Value	0

7.2.73 Object 6413h: CO Lower Controller Output Limit Ymin

The value describes the lower limit for the controller output. The value is given in percent with one decimal digit after the comma (see Object 6410h: CO Effective Controller Output Y).

OBJECT DESCRIPTION

Index	6413h
Name	Lower Controller Output Limit Ymin
Object Code	ARRAY
Data Type	Unsigned16
Category	Optional

ENTRY DESCRIPTION

Sub-Index	0h
Description	number of entries
Entry Category	Mandatory
Access	ro
PDO Mapping	No
Value Range	1 - C7h
Default Value	No

Sub-Index	1h
Description	CO Lower Controller Output Limit 1
Entry Category	Mandatory
Access	rw
PDO Mapping	No
Value Range	0000h – 03E8h, FC18h - FFFFh
Default Value	No

Sub-Index	2h
Description	CO Lower Controller Output Limit 2
Entry Category	Optional
Access	rw
PDO Mapping	No
Value Range	0000h – 03E8h, FC18h - FFFFh
Default Value	No

to

Sub-Index	C7h
Description	CO Lower Controller Output Limit 199
Entry Category	Optional
Access	rw
PDO Mapping	No
Value Range	0000h – 03E8h, FC18h - FFFFh
Default Value	No

7.2.74 Object 6414h: CO Upper Controller Output Limit Ymax

The value describes the lower limit for the controller output. The value is given in percent with one decimal digit after the comma (see Object 6410h: CO Effective Controller Output Y).

OBJECT DESCRIPTION

Index	6414h
Name	Upper Controller Output Limit Ymax
Object Code	ARRAY
Data Type	Unsigned16
Category	Optional

ENTRY DESCRIPTION

Sub-Index	0h
Description	number of entries
Entry Category	Mandatory
Access	ro
PDO Mapping	No
Value Range	1 - C7h
Default Value	No

Sub-Index	1h
Description	CO Upper Controller Output Limit 1
Entry Category	Mandatory
Access	rw
PDO Mapping	No
Value Range	0000h – 03E8h, FC18h - FFFFh
Default Value	No

Sub-Index	2h
Description	CO Upper Controller Output Limit 2
Entry Category	Optional
Access	rw
PDO Mapping	No
Value Range	0000h – 03E8h, FC18h - FFFFh
Default Value	No

to

Sub-Index	C7h
Description	CO Upper Controller Output Limit 199
Entry Category	Optional
Access	rw
PDO Mapping	No
Value Range	0000h – 03E8h, FC18h - FFFFh
Default Value	No

7.2.75 Object 6415h: CO Physical Unit Controller Output

The object describes the physical unit of the objects beginning from 6410h to 6414h (see Object 6131h: AI Physical unit PV).

OBJECT DESCRIPTION

Index	6415h
Name	CO Physical Unit Controller Output
Object Code	ARRAY
Data Type	Unsigned32
Category	Mandatory

ENTRY DESCRIPTION

Sub-Index	0h
Description	number of entries
Entry Category	Mandatory
Access	ro
PDO Mapping	No
Value Range	1 - C7h
Default Value	No

Sub-Index	1h
Description	CO Physical Unit Controller Output 1
Entry Category	Mandatory
Access	rw
PDO Mapping	No
Value Range	Unsigned32
Default Value	No

Sub-Index	2h
Description	CO Physical Unit Controller Output 2
Entry Category	Optional
Access	rw
PDO Mapping	No
Value Range	Unsigned32
Default Value	No

to

Sub-Index	C7h
Description	CO Physical Unit Controller Output 199
Entry Category	Optional
Access	rw
PDO Mapping	No
Value Range	Unsigned32
Default Value	No

7.2.76 Object 6420h: CO Set Point switch W/W2

Set Point Switch W/W2 for switching between first and second set point.

FALSE – selects the first set point

TRUE – selects the second set point

OBJECT DESCRIPTION

Index	6420h
Name	Set Point Switch W/W2
Object Code	ARRAY
Data Type	Boolean
Category	Mandatory

ENTRY DESCRIPTION

Sub-Index	0h
Description	number of entries
Entry Category	Mandatory
Access	ro
PDO Mapping	No
Value Range	1 - C7h
Default Value	No

Sub-Index	1h
Description	Set Point Switch 1
Entry Category	Mandatory
Access	rw
PDO Mapping	Possible
Value Range	Boolean
Default Value	FALSE

Sub-Index	2h
Description	Set Point Switch 2
Entry Category	Optional
Access	rw
PDO Mapping	Possible
Value Range	Boolean
Default Value	FALSE

to

Sub-Index	C7h
Description	Set Point Switch 199
Entry Category	Optional
Access	rw
PDO Mapping	Possible
Value Range	Boolean
Default Value	FALSE

7.2.77 Object 6421h: CO Automatic/Manual Mode switch A/M

Switches between automatic and manual mode.

FALSE – selects the automatic mode

TRUE – selects the manual mode

OBJECT DESCRIPTION

Index	6421h
Name	Automatic Manual Mode A/M
Object Code	ARRAY
Data Type	Boolean
Category	Mandatory

ENTRY DESCRIPTION

Sub-Index	0h
Description	number of entries
Entry Category	Mandatory
Access	ro
PDO Mapping	No
Value Range	1 - C7h
Default Value	No

Sub-Index	1h
Description	Automatic Manual Mode 1
Entry Category	Mandatory
Access	rw
PDO Mapping	Possible
Value Range	Boolean
Default Value	FALSE

Sub-Index	2h
Description	Automatic Manual Mode 2
Entry Category	Optional
Access	rw
PDO Mapping	Possible
Value Range	Boolean
Default Value	FALSE

to

Sub-Index	C7h
Description	Automatic Manual Mode 199
Entry Category	Optional
Access	rw
PDO Mapping	Possible
Value Range	Boolean
Default Value	FALSE

7.2.78 Object 6422h: CO Controller On/Off

Switches the controller on or off.

TRUE – switches the controller on

FALSE – switches the controller off

OBJECT DESCRIPTION

Index	6412h
Name	Controller On/ Off
Object Code	ARRAY
Data Type	Boolean
Category	Mandatory

ENTRY DESCRIPTION

Sub-Index	0h
Description	number of entries
Entry Category	Mandatory
Access	ro
PDO Mapping	No
Value Range	1 - C7h
Default Value	No

Sub-Index	1h
Description	Controller On /Off 1
Entry Category	Mandatory
Access	rw
PDO Mapping	Possible
Value Range	Boolean
Default Value	FALSE

Sub-Index	2h
Description	Controller On/ Off 2
Entry Category	Optional
Access	rw
PDO Mapping	Possible
Value Range	Boolean
Default Value	FALSE

to

Sub-Index	C7h
Description	Controller On /Off 199
Entry Category	Optional
Access	rw
PDO Mapping	Possible
Value Range	Boolean
Default Value	FALSE

7.2.79 Object 6423h: CO Controller mode

Selects the mode of the controller. The meaning is shown below.

control byte	Mode
00h	2-point controller
01h	3-point controller
02h	3-point stepping controller
03h	continuous controller
04h	reserved for future use
...	...
7Fh	reserved for future use
80h	manufacturer specific controller type
...	...
FFh	manufacturer specific controller type

OBJECT DESCRIPTION

Index	6423h
Name	Controller Mode
Object Code	ARRAY
Data Type	Unsigned8
Category	Mandatory

ENTRY DESCRIPTION

Sub-Index	0h
Description	number of entries
Entry Category	Mandatory
Access	ro
PDO Mapping	No
Value Range	1 - C7h
Default Value	No

Sub-Index	1h
Description	Controller Mode 1
Entry Category	Mandatory
Access	rw
PDO Mapping	Possible
Value Range	Unsigned8
Default Value	No

Sub-Index	2h
Description	Controller Mode 2
Entry Category	Optional
Access	rw
PDO Mapping	Possible
Value Range	Unsigned8
Default Value	No

to

Sub-Index	C7h
Description	Controller Mode 199
Entry Category	Optional
Access	rw
PDO Mapping	Possible
Value Range	Unsigned8
Default Value	No

7.2.80 Object 6424h: CO Self Optimization on/off

This object switches the self-optimisation mode on or off.

FALSE – switches the self-optimisation off

TRUE – switches the self-optimisation on

OBJECT DESCRIPTION

Index	6424h
Name	CO Self Optimisation On/Off
Object Code	ARRAY
Data Type	Boolean
Category	Optional

ENTRY DESCRIPTION

Sub-Index	0h
Description	number of entries
Entry Category	Mandatory
Access	ro
PDO Mapping	No
Value Range	1 - C7h
Default Value	No

Sub-Index	1h
Description	CO Self Optimization 1
Entry Category	Mandatory
Access	rw
PDO Mapping	Possible
Value Range	Boolean
Default Value	FALSE

Sub-Index	2h
Description	CO Self Optimization 2
Entry Category	Optional
Access	rw
PDO Mapping	Possible
Value Range	Boolean
Default Value	FALSE

to

Sub-Index	C7h
Description	CO Self Optimization 199
Entry Category	Optional
Access	rw
PDO Mapping	Possible
Value Range	Boolean
Default Value	FALSE

7.2.81 Object 6425h: CO Control Byte

The control byte maps the objects for set-point switch, controller on/off etc. in one single object. The main purpose for this mapping is to have a single object for the PDO mapping.

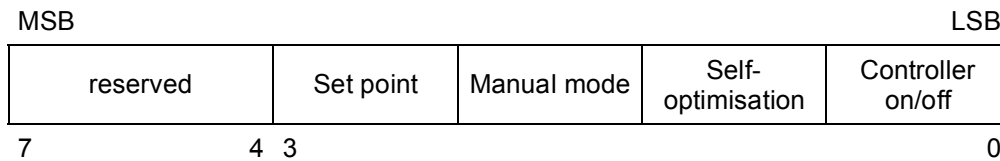

Value	Meaning
0	disable function
1	enable function

OBJECT DESCRIPTION

Index	6425h
Name	CO Control Byte
Object Code	ARRAY
Data Type	Unsigned8
Category	Mandatory

ENTRY DESCRIPTION

Sub-Index	0h
Description	number of entries
Entry Category	Mandatory
Access	ro
PDO Mapping	No
Value Range	1 - C7h
Default Value	No

Sub-Index	1h
Description	CO Control Byte 1
Entry Category	Mandatory
Access	rw
PDO Mapping	Possible
Value Range	Unsigned8
Default Value	0

Sub-Index	2h
Description	CO Control Byte 2
Entry Category	Optional
Access	rw
PDO Mapping	Possible
Value Range	Unsigned8
Default Value	0

to

Sub-Index	C7h
Description	CO Control Byte 199
Entry Category	Optional
Access	rw
PDO Mapping	Possible
Value Range	Unsigned8
Default Value	0

7.2.82 Object 6426h: CO Control byte enable

This bit mask enables the single bits within the CO Control byte.

OBJECT DESCRIPTION

Index	6426h
Name	CO Control Byte Enable
Object Code	ARRAY
Data Type	Unsigned8
Category	Optional

ENTRY DESCRIPTION

Sub-Index	0h
Description	number of entries
Entry Category	Mandatory
Access	ro
PDO Mapping	No
Value Range	1 - C7h
Default Value	No

Sub-Index	1h
Description	CO Control Byte Enable 1
Entry Category	Mandatory
Access	rw
PDO Mapping	No
Value Range	Unsigned8
Default Value	No

Sub-Index	2h
Description	CO Control Byte Enable 2
Entry Category	Optional
Access	rw
PDO Mapping	No
Value Range	Unsigned8
Default Value	No

to

Sub-Index	C7h
Description	CO Control Byte Enable 199
Entry Category	Optional
Access	rw
PDO Mapping	No
Value Range	Unsigned8
Default Value	No

7.2.83 Object 6427h: CO Status Word

The status word holds the status of the controller. The main purpose for this object is to have a single object for the PDO mapping.

The single bits of the CO status information have the following meaning:

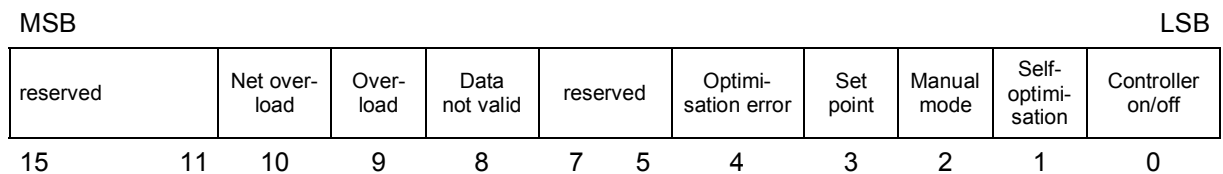

Value	Meaning
0	not valid (Not occurred)
1	valid (occurred)

This object is read-only. Although this object is nearly a copy of the object 6425h, it may hold a different value. If, for example, the user wants to switch a controller on, the value TRUE is written to object 6422h. The corresponding bit will be set in object 6425h. However the specified control zone may not be switched on due to an error, so bit 0 in object 6427h will not change to 1.

OBJECT DESCRIPTION

Index	6427h
Name	CO Status Word
Object Code	ARRAY
Data Type	Unsigned16
Category	Mandatory

ENTRY DESCRIPTION

Sub-Index	0h
Description	number of entries
Entry Category	Mandatory
Access	ro
PDO Mapping	No
Value Range	1 - C7h
Default Value	No

Sub-Index	1h
Description	CO Status Word 1
Entry Category	Mandatory
Access	ro
PDO Mapping	Possible
Value Range	Unsigned16
Default Value	No

Sub-Index	2h
Description	CO Status Word 2
Entry Category	Optional
Access	ro
PDO Mapping	Possible
Value Range	Unsigned16
Default Value	No

to

Sub-Index	C7h
Description	CO Status Word 199
Entry Category	Optional
Access	ro
PDO Mapping	Possible
Value Range	0 - FFFFH
Default Value	No

7.2.84 Object x430h: CO Minimum Pulse Time Tmin1

The physical unit of this object is seconds. The number of decimal digits of this object is defined by object 6434h.

OBJECT DESCRIPTION

Index	x430h
Name	Minimum Pulse Time Tmin1
Object Code	ARRAY
Data Type	Float, Integer16, Integer24, Integer32
Category	Optional

ENTRY DESCRIPTION

Sub-Index	0h
Description	number of entries
Entry Category	Mandatory
Access	ro
PDO Mapping	No
Value Range	1 - C7h
Default Value	No

Sub-Index	1h
Description	Minimum Pulse Time Tmin1 1
Entry Category	Mandatory
Access	rw
PDO Mapping	No
Value Range	data type specific
Default Value	No

Sub-Index	2h
Description	Minimum Pulse Time Tmin1 2
Entry Category	Optional
Access	rw
PDO Mapping	No
Value Range	data type specific
Default Value	No

to

Sub-Index	C7h
Description	Minimum Pulse Time Tmin1 199
Entry Category	Optional
Access	rw
PDO Mapping	No
Value Range	data type specific
Default Value	No

7.2.85 Object x431h: CO Minimum Pulse Time Tmin2

The physical unit of this object is seconds. The number of decimal digits of this object is defined by object 6434h.

OBJECT DESCRIPTION

Index	x431h
Name	Minmum Pulse Time Tmin2
Object Code	ARRAY
Data Type	Float, Integer16, Integer24, Integer32
Category	Optional

ENTRY DESCRIPTION

Sub-Index	0h
Description	number of entries
Entry Category	Mandatory
Access	ro
PDO Mapping	No
Value Range	1 - C7h
Default Value	No

Sub-Index	1h
Description	Minimum Pulse Time Tmin2 1
Entry Category	Mandatory
Access	rw
PDO Mapping	No
Value Range	data type specific
Default Value	No

Sub-Index	2h
Description	Minimum Pulse Time Tmin2 2
Entry Category	Optional
Access	rw
PDO Mapping	No
Value Range	data type specific
Default Value	No

to

Sub-Index	C7h
Description	Minimum Pulse Time Tmin2 199
Entry Category	Optional
Access	rw
PDO Mapping	No
Value Range	data type specific
Default Value	No

7.2.86 Object x432h: CO Motor Response Time Tm

Parameter is used for three point stepping controllers. The physical unit of this object is seconds. The number of decimal digits of this object is defined by object 6434h.

OBJECT DESCRIPTION

Index	x432h
Name	CO Motor Response Time Tm
Object Code	ARRAY
Data Type	Float, Integer16, Integer24, Integer32
Category	Optional

ENTRY DESCRIPTION

Sub-Index	0h
Description	number of entries
Entry Category	Mandatory
Access	ro
PDO Mapping	No
Value Range	1 - C7h
Default Value	No

Sub-Index	1h
Description	CO Motor Response Time 1
Entry Category	Mandatory
Access	rw
PDO Mapping	No
Value Range	data type specific
Default Value	No

Sub-Index	2h
Description	CO Motor Response Time 2
Entry Category	Optional
Access	rw
PDO Mapping	No
Value Range	data type specific
Default Value	No

to

Sub-Index	C7h
Description	CO Motor Response Time 199
Entry Category	Optional
Access	rw
PDO Mapping	No
Value Range	data type specific
Default Value	No

7.2.87 Object x433h: CO Min. Pulse Length Tpuls

If the value is set to 0 the pulse length is switched off. The physical unit of this object is seconds. The number of decimal digits of this object is defined by object 6434h.

OBJECT DESCRIPTION

Index	x433h
Name	CO Min Pulse Length Tpuls
Object Code	ARRAY
Data Type	Float, Integer16, Integer24, Integer32
Category	Optional

ENTRY DESCRIPTION

Sub-Index	0h
Description	number of entries
Entry Category	Mandatory
Access	ro
PDO Mapping	No
Value Range	1 - C7h
Default Value	No

Sub-Index	1h
Description	CO Min Pulse Length 1
Entry Category	Mandatory
Access	rw
PDO Mapping	No
Value Range	data type specific
Default Value	No

Sub-Index	2h
Description	CO Min Pulse Length 2
Entry Category	Optional
Access	rw
PDO Mapping	No
Value Range	data type specific
Default Value	No

to

Sub-Index	C7h
Description	CO Min Pulse Length 199
Entry Category	Optional
Access	rw
PDO Mapping	No
Value Range	data type specific
Default Value	No

7.2.88 Object 6434h: CO Physical Unit Pulse Timing

The object describes the physical unit of the objects beginning from 6430h to 6433h.

OBJECT DESCRIPTION

Index	6434h
Name	CO Physical Unit Pulse Timing
Object Code	ARRAY
Data Type	Unsigned32
Category	Optional

ENTRY DESCRIPTION

Sub-Index	0h
Description	number of entries
Entry Category	Mandatory
Access	ro
PDO Mapping	No
Value Range	1 - C7h
Default Value	No

Sub-Index	1h
Description	CO Physical Unit Pulse Timing 1
Entry Category	Mandatory
Access	rw
PDO Mapping	No
Value Range	Unsigned32
Default Value	0003 0000h

Sub-Index	2h
Description	CO Physical Unit Pulse Timing 2
Entry Category	Optional
Access	rw
PDO Mapping	No
Value Range	Unsigned32
Default Value	0003 0000h

to

Sub-Index	C7h
Description	CO Physical Unit Pulse Timing 199
Entry Category	Optional
Access	rw
PDO Mapping	No
Value Range	Unsigned32
Default Value	0003 0000h

7.2.89 Object 6435h: CO Decimal Digits Pulse Timing

The object describes the number of decimal digits of the objects beginning from x430h to x433h.

OBJECT DESCRIPTION

Index	6434h
Name	CO Decimal Digits PT
Object Code	ARRAY
Data Type	Unsigned8
Category	Optional

ENTRY DESCRIPTION

Sub-Index	0h
Description	number of entries
Entry Category	Mandatory
Access	ro
PDO Mapping	No
Value Range	1 - C7h
Default Value	No

Sub-Index	1h
Description	CO Decimal Digits PT 1
Entry Category	Mandatory
Access	rw
PDO Mapping	No
Value Range	0 - 15
Default Value	No

Sub-Index	2h
Description	CO Decimal Digits PT 2
Entry Category	Optional
Access	rw
PDO Mapping	No
Value Range	0 - 15
Default Value	No

to

Sub-Index	C7h
Description	CO Decimal Digits PT 199
Entry Category	Optional
Access	rw
PDO Mapping	No
Value Range	0 - 15
Default Value	No

7.2.90 Object x440h: CO Neutral Zone 3point Xsh1

The object describes the neutral zone for a 3-point controller. The physical unit and the number of decimal digits are taken from objects 6406h and 6407h.

OBJECT DESCRIPTION

Index	x440h
Name	Neutral zone 3point Xsh1
Object Code	ARRAY
Data Type	Float, Integer16, Integer24, Integer32
Category	Optional

ENTRY DESCRIPTION

Sub-Index	0h
Description	number of entries
Entry Category	Mandatory
Access	ro
PDO Mapping	No
Value Range	1 - C7h
Default Value	No

Sub-Index	1h
Description	Neutral zone 3point Xsh1 1
Entry Category	Mandatory
Access	rw
PDO Mapping	No
Value Range	data type specific
Default Value	No

Sub-Index	2h
Description	Neutral zone 3point Xsh1 2
Entry Category	Optional
Access	rw
PDO Mapping	No
Value Range	data type specific
Default Value	No

to

Sub-Index	C7h
Description	Neutral zone 3point Xsh1 199
Entry Category	Optional
Access	rw
PDO Mapping	No
Value Range	data type specific
Default Value	No

7.2.91 Object x441h: CO Neutral zone 3point Xsh2

The object describes the neutral zone for a 3-point controller. The physical unit and the number of decimal digits are taken from objects 6406h and 6407h.

OBJECT DESCRIPTION

Index	x441h
Name	Neutral zone 3point Xsh2
Object Code	ARRAY
Data Type	Float, Integer16, Integer24, Integer32
Category	Optional

ENTRY DESCRIPTION

Sub-Index	0h
Description	number of entries
Entry Category	Mandatory
Access	ro
PDO Mapping	No
Value Range	1 - C7h
Default Value	No

Sub-Index	1h
Description	Neutral zone 3point Xsh2 1
Entry Category	Mandatory
Access	rw
PDO Mapping	No
Value Range	data type specific
Default Value	No

Sub-Index	2h
Description	Neutral zone 3point Xsh2 2
Entry Category	Optional
Access	rw
PDO Mapping	No
Value Range	data type specific
Default Value	No

to

Sub-Index	C7h
Description	Neutral zone 3point Xsh2 199
Entry Category	Optional
Access	rw
PDO Mapping	No
Value Range	data type specific
Default Value	No

7.2.92 Object x442h: CO Neutral zone 3point stepping Xsh

The object describes the neutral zone for a 3-point controller. The physical unit and the number of decimal digits are taken from objects 6406h and 6407h.

OBJECT DESCRIPTION

Index	x442h
Name	CO Neutral zone 3point stepping Xsh
Object Code	ARRAY
Data Type	Float, Integer16, Integer24, Integer32
Category	Optional

ENTRY DESCRIPTION

Sub-Index	0h
Description	number of entries
Entry Category	Mandatory
Access	ro
PDO Mapping	No
Value Range	1 - C7h
Default Value	No

Sub-Index	1h
Description	CO Neutral zone 3point stepping 1
Entry Category	Mandatory
Access	rw
PDO Mapping	No
Value Range	data type specific
Default Value	No

Sub-Index	2h
Description	CO Neutral zone 3point stepping 2
Entry Category	Optional
Access	rw
PDO Mapping	No
Value Range	data type specific
Default Value	No

to

Sub-Index	C7h
Description	CO Neutral zone 3point stepping 199
Entry Category	Optional
Access	rw
PDO Mapping	No
Value Range	data type specific
Default Value	No

7.2.93 Object x443h: CO Switching difference of signaller Xsd1

The object describes the switching difference for a 3-point stepping controller. The physical unit and the number of decimal digits are taken from objects 6406h and 6407h.

OBJECT DESCRIPTION

Index	x443h
Name	CO Switching difference of signaller Xsd1
Object Code	ARRAY
Data Type	Float, Integer16, Integer24, Integer32
Category	Optional

ENTRY DESCRIPTION

Sub-Index	0h
Description	number of entries
Entry Category	Mandatory
Access	ro
PDO Mapping	No
Value Range	1 - C7h
Default Value	No

Sub-Index	1h
Description	CO Switching difference of signaller Xsd1 1
Entry Category	Mandatory
Access	rw
PDO Mapping	No
Value Range	data type specific
Default Value	No

Sub-Index	2h
Description	CO Switching difference of signaller Xsd1 2
Entry Category	Optional
Access	rw
PDO Mapping	No
Value Range	data type specific
Default Value	No

to

Sub-Index	C7h
Description	CO Switching difference of signaller Xsd1 199
Entry Category	Optional
Access	rw
PDO Mapping	No
Value Range	data type specific
Default Value	No

7.2.94 Object x444h: CO Switching difference of additional Contact Xsd2

The object describes the switching difference for a 3-point stepping controller. The physical unit and the number of decimal digits are taken from objects 6406h and 6407h.

OBJECT DESCRIPTION

Index	x444h
Name	Switching difference of additional Contact Xsd2
Object Code	ARRAY
Data Type	Float, Integer16, Integer24, Integer32
Category	Optional

ENTRY DESCRIPTION

Sub-Index	0h
Description	number of entries
Entry Category	Mandatory
Access	ro
PDO Mapping	No
Value Range	1 - C7h
Default Value	No

Sub-Index	1h
Description	Switching difference of additional contact Xsd2 1
Entry Category	Mandatory
Access	rw
PDO Mapping	No
Value Range	data type specific
Default Value	No

Sub-Index	2h
Description	Switching difference of additional contact Xsd2 2
Entry Category	Optional
Access	rw
PDO Mapping	No
Value Range	data type specific
Default Value	No

to

Sub-Index	C7h
Description	Switching difference of additional contactXsd2 199
Entry Category	Optional
Access	rw
PDO Mapping	No
Value Range	data type specific
Default Value	No

7.2.95 Object x445h: CO Trigger point separation of additional contact LW

The object describes the trigger point for a 3-point stepping controller. The physical unit and the number of decimal digits are taken from objects 6406h and 6407h.

OBJECT DESCRIPTION

Index	x445h
Name	Trigger point separation of add. contact LW
Object Code	ARRAY
Data Type	Float, Integer16, Integer24, Integer32
Category	Optional

ENTRY DESCRIPTION

Sub-Index	0h
Description	number of entries
Entry Category	Mandatory
Access	ro
PDO Mapping	No
Value Range	1 - C7h
Default Value	No

Sub-Index	1h
Description	Trigger point separation of add. contact LW 1
Entry Category	Mandatory
Access	rw
PDO Mapping	No
Value Range	data type specific
Default Value	No

Sub-Index	2h
Description	Trigger point separation of add. contact LW 2
Entry Category	Optional
Access	rw
PDO Mapping	No
Value Range	data type specific
Default Value	No

to

Sub-Index	C7h
Description	Trigger point separation of add. contact LW 199
Entry Category	Optional
Access	rw
PDO Mapping	No
Value Range	data type specific
Default Value	No

7.2.96 Object x450h: CO Proportional Band Xp1

The object describes the parameter Xp of the PID-algorithm. The value is given in percent with one digit after the comma (see Object 6410h: CO Effective Controller Output Y for representation as Integer16).

OBJECT DESCRIPTION

Index	x440h
Name	CO Proportional Band Xp1
Object Code	ARRAY
Data Type	Float, Integer16, Integer24, Integer32
Category	Optional

ENTRY DESCRIPTION

Sub-Index	0h
Description	number of entries
Entry Category	Mandatory
Access	ro
PDO Mapping	No
Value Range	1 - C7h
Default Value	No

Sub-Index	1h
Description	CO Proportional Band Xp1 1
Entry Category	Mandatory
Access	rw
PDO Mapping	No
Value Range	data type specific
Default Value	No

Sub-Index	2h
Description	CO Proportional Band Xp1 2
Entry Category	Optional
Access	rw
PDO Mapping	No
Value Range	data type specific
Default Value	No

to

Sub-Index	C7h
Description	CO Proportional Band Xp1 199
Entry Category	Optional
Access	rw
PDO Mapping	No
Value Range	data type specific
Default Value	No

7.2.97 Object x451h: CO Proportional Band Xp2

The object describes the parameter Xp of the PID-algorithm. The value is given in percent with one digit after the comma (see Object 6410h: CO Effective Controller Output Y for representation as Integer16).

OBJECT DESCRIPTION

Index	x451h
Name	CO Proportional Band Xp2
Object Code	ARRAY
Data Type	Float, Integer16, Integer24, Integer32
Category	Optional

ENTRY DESCRIPTION

Sub-Index	0h
Description	number of entries
Entry Category	Mandatory
Access	ro
PDO Mapping	No
Value Range	1 - C7h
Default Value	No

Sub-Index	1h
Description	CO Proportional Band Xp2 1
Entry Category	Mandatory
Access	rw
PDO Mapping	No
Value Range	data type specific
Default Value	No

Sub-Index	2h
Description	CO Proportional Band Xp2 2
Entry Category	Optional
Access	rw
PDO Mapping	No
Value Range	data type specific
Default Value	No

to

Sub-Index	C7h
Description	CO Proportional Band Xp2 199
Entry Category	Optional
Access	rw
PDO Mapping	No
Value Range	data type specific
Default Value	No

7.2.98 Object x452h: CO Integral Action Time Tn1

The object describes the parameter Tn of the PID-algorithm. The physical unit and the number of decimal digits is given by objects 6458h and 6459h.

OBJECT DESCRIPTION

Index	x452h
Name	CO Integral Action Time Tn1
Object Code	ARRAY
Data Type	Float, Integer16, Integer24, Integer32
Category	Optional

ENTRY DESCRIPTION

Sub-Index	0h
Description	number of entries
Entry Category	Mandatory
Access	ro
PDO Mapping	No
Value Range	1 - C7h
Default Value	No

Sub-Index	1h
Description	CO Integral Action Time Tn1 1
Entry Category	Mandatory
Access	rw
PDO Mapping	No
Value Range	data type specific
Default Value	No

Sub-Index	2h
Description	CO Integral Action Time Tn1 2
Entry Category	Optional
Access	rw
PDO Mapping	No
Value Range	data type specific
Default Value	No

to

Sub-Index	C7h
Description	CO Integral Action Time Tn1 199
Entry Category	Optional
Access	rw
PDO Mapping	No
Value Range	data type specific
Default Value	No

7.2.99 Object x453h: CO Integral Action Time Tn2

The object describes the parameter Tn of the PID-algorithm. The physical unit and the number of decimal digits is given by objects 6458h and 6459h.

OBJECT DESCRIPTION

Index	x453h
Name	CO Integral Action Time Tn2
Object Code	ARRAY
Data Type	Float, Integer16, Integer24, Integer32
Category	Optional

ENTRY DESCRIPTION

Sub-Index	0h
Description	number of entries
Entry Category	Mandatory
Access	ro
PDO Mapping	No
Value Range	1 - C7h
Default Value	No

Sub-Index	1h
Description	CO Integral Action Time Tn2 1
Entry Category	Mandatory
Access	rw
PDO Mapping	No
Value Range	data type specific
Default Value	No

Sub-Index	2h
Description	CO Integral Action Time Tn2 2
Entry Category	Optional
Access	rw
PDO Mapping	No
Value Range	data type specific
Default Value	No

to

Sub-Index	C7h
Description	CO Integral Action Time Tn2 199
Entry Category	Optional
Access	rw
PDO Mapping	No
Value Range	data type specific
Default Value	No

7.2.100 Object x454h: CO Derivate Action Time Tv1

The object describes the parameter Tv of the PID-algorithm. The physical unit and the number of decimal digits is given by objects 6458h and 6459h.

OBJECT DESCRIPTION

Index	x454h
Name	CO Derivate Action Time Tv1
Object Code	ARRAY
Data Type	Float, Integer16, Integer24, Integer32
Category	Optional

ENTRY DESCRIPTION

Sub-Index	0h
Description	number of entries
Entry Category	Mandatory
Access	ro
PDO Mapping	No
Value Range	1 - C7h
Default Value	No

Sub-Index	1h
Description	CO Derivate Action Time Tv1 1
Entry Category	Mandatory
Access	rw
PDO Mapping	No
Value Range	data type specific
Default Value	No

Sub-Index	2h
Description	CO Derivate Action Time Tv1 2
Entry Category	Optional
Access	rw
PDO Mapping	No
Value Range	data type specific
Default Value	No

to

Sub-Index	C7h
Description	CO Derivate Action Time Tv1 199
Entry Category	Optional
Access	rw
PDO Mapping	No
Value Range	data type specific
Default Value	No

7.2.101 Object x455h: CO Derivate Action Time Tv2

The object describes the parameter Tv of the PID-algorithm. The physical unit and the number of decimal digits is given by objects 6458h and 6459h.

OBJECT DESCRIPTION

Index	x455h
Name	CO Derivate Action Time Tv2
Object Code	ARRAY
Data Type	Float, Integer16, Integer24, Integer32
Category	Optional

ENTRY DESCRIPTION

Sub-Index	0h
Description	number of entries
Entry Category	Mandatory
Access	ro
PDO Mapping	No
Value Range	1 - C7h
Default Value	No

Sub-Index	1h
Description	CO Derivate Action Time Tv2 1
Entry Category	Mandatory
Access	rw
PDO Mapping	No
Value Range	data type specific
Default Value	No

Sub-Index	2h
Description	CO Derivate Action Time Tv2 2
Entry Category	Optional
Access	rw
PDO Mapping	No
Value Range	data type specific
Default Value	No

to

Sub-Index	C7h
Description	CO Derivate Action Time Tv2 199
Entry Category	Optional
Access	rw
PDO Mapping	No
Value Range	data type specific
Default Value	No

7.2.102 Object x456h: CO Cycle Time T1

The object describes the cycle time of the PID-algorithm. The physical unit and the number of decimal digits is given by objects 6458h and 6459h.

OBJECT DESCRIPTION

Index	x456h
Name	CO Cycle Time T1
Object Code	ARRAY
Data Type	Float, Integer16, Integer24, Integer32
Category	Optional

ENTRY DESCRIPTION

Sub-Index	0h
Description	number of entries
Entry Category	Mandatory
Access	ro
PDO Mapping	No
Value Range	1 - C7h
Default Value	No

Sub-Index	1h
Description	CO Cycle Time T1 1
Entry Category	Mandatory
Access	rw
PDO Mapping	No
Value Range	data type specific
Default Value	No

Sub-Index	2h
Description	CO Cycle Time T1 2
Entry Category	Optional
Access	rw
PDO Mapping	No
Value Range	data type specific
Default Value	No

to

Sub-Index	199
Description	CO Cycle Time T1 199
Entry Category	Optional
Access	rw
PDO Mapping	No
Value Range	data type specific
Default Value	No

7.2.103 Object x457h: CO Cycle Time T2

The object describes the cycle time of the PID-algorithm. The physical unit and the number of decimal digits is given by objects 6458h and 6459h.

OBJECT DESCRIPTION

Index	x457h
Name	CO Cycle Time T2
Object Code	ARRAY
Data Type	Float, Integer16, Integer24, Integer32
Category	Optional

ENTRY DESCRIPTION

Sub-Index	0h
Description	number of entries
Entry Category	Mandatory
Access	ro
PDO Mapping	No
Value Range	1 - C7h
Default Value	No

Sub-Index	1h
Description	CO Cycle Time T2 1
Entry Category	Mandatory
Access	rw
PDO Mapping	No
Value Range	data type specific
Default Value	No

Sub-Index	2h
Description	CO Cycle Time T2 2
Entry Category	Optional
Access	rw
PDO Mapping	No
Value Range	data type specific
Default Value	No

to

Sub-Index	C7h
Description	CO Cycle Time T2 199
Entry Category	Optional
Access	rw
PDO Mapping	No
Value Range	data type specific
Default Value	No

7.2.104 Object 6458h: CO Physical Unit PID Timing

The object describes the physical unit of the objects beginning from x450h to x457h (see Object 6131h: AI Physical unit PV).

OBJECT DESCRIPTION

Index	6458h
Name	CO Physical Unit PID
Object Code	ARRAY
Data Type	Unsigned32
Category	Optional

ENTRY DESCRIPTION

Sub-Index	0h
Description	number of entries
Entry Category	Mandatory
Access	ro
PDO Mapping	No
Value Range	1 - C7h
Default Value	No

Sub-Index	1h
Description	CO Physical Unit PID 1
Entry Category	Mandatory
Access	rw
PDO Mapping	No
Value Range	Unsigned32
Default Value	0003 0000h

Sub-Index	2h
Description	CO Physical Unit PID 2
Entry Category	Optional
Access	rw
PDO Mapping	No
Value Range	Unsigned32
Default Value	0003 0000h

to

Sub-Index	C7h
Description	CO Physical Unit PID 199
Entry Category	Optional
Access	rw
PDO Mapping	No
Value Range	Unsigned32
Default Value	0003 0000h

7.2.105 Object 6459h: CO Decimal Digits PID Timing

The object describes the number of decimal digits of the objects beginning from x450h to x457h.

OBJECT DESCRIPTION

Index	6459h
Name	CO Decimal Digits PID
Object Code	ARRAY
Data Type	Unsigned8
Category	Optional

ENTRY DESCRIPTION

Sub-Index	0h
Description	number of entries
Entry Category	Mandatory
Access	ro
PDO Mapping	No
Value Range	1 - C7h
Default Value	No

Sub-Index	1h
Description	CO Decimal Digits PID 1
Entry Category	Mandatory
Access	rw
PDO Mapping	No
Value Range	0 - 15
Default Value	No

Sub-Index	2h
Description	CO Decimal Digits PID 2
Entry Category	Optional
Access	rw
PDO Mapping	No
Value Range	0 - 15
Default Value	No

to

Sub-Index	C7h
Description	CO Decimal Digits PID 199
Entry Category	Optional
Access	rw
PDO Mapping	No
Value Range	0 - 15
Default Value	No

7.2.106 Object x500h: AL 1 Input value

This object represents the process value, which is the input to the alarm function block.

It is scaled in the physical unit of process values (e.g. degrees centigrade, kg, kN, mm etc.).

OBJECT DESCRIPTION

Index	x500h
Name	AL 1 Input value
Object Code	ARRAY
Data Type	Float, Integer16, Integer24, Integer32
Category	Mandatory

ENTRY DESCRIPTION

Sub-Index	0h
Description	number of entries
Entry Category	Mandatory
Access	ro
PDO Mapping	No
Value Range	1 - C7h
Default Value	No

Sub-Index	1h
Description	AL 1 Input value 1
Entry Category	Mandatory
Access	rw
PDO Mapping	Possible
Value Range	data type specific
Default Value	No

Sub-Index	2h
Description	AL 1 Input value 2
Entry Category	Optional
Access	rw
PDO Mapping	Possible
Value Range	data type specific
Default Value	No

to

Sub-Index	C7h
Description	AL 1 Input value 199
Entry Category	Optional
Access	rw
PDO Mapping	Possible
Value Range	data type specific
Default Value	No

7.2.107 Object 6503h: AL 1 Link input

This object describes the source for the AL Input Value if it lies within another functional block of the same device. The object defined by index and sub-index is directly linked to the AL Input Value.

OBJECT DESCRIPTION

Index	6503h
Name	AL 1 Link input
Object Code	RECORD
Data Type	PDOmapping
Category	Optional

ENTRY DESCRIPTION

Sub-Index	0h
Description	number of entries
Entry Category	Mandatory
Access	ro
PDO Mapping	No
Value Range	1 – C7h
Default Value	No

Sub-Index	1h
Description	AL 1 Link input 1
Entry Category	Mandatory
Access	rw
PDO Mapping	No
Value Range	Unsigned32
Default Value	No

Sub-Index	2h
Description	AL 1 Link input 2
Entry Category	Optional
Access	rw
PDO Mapping	No
Value Range	Unsigned32
Default Value	No

to

Sub-Index	C7h
Description	AL 1 Link input 199
Entry Category	Optional
Access	rw
PDO Mapping	No
Value Range	Unsigned32
Default Value	No

7.2.108 Object x504h: AL 1 Alternate input value

This object represents the process value, which is the alternate input to the alarm function block. This alternate input is only used if functionality needs two input values.

It is scaled in the physical unit of process values (e.g. degrees centigrade, kg, kN, mm etc.).

OBJECT DESCRIPTION

Index	x504h
Name	AL 1 Alternate input value
Object Code	ARRAY
Data Type	Float, Integer16, Integer24, Integer32
Category	Optional

ENTRY DESCRIPTION

Sub-Index	0h
Description	number of entries
Entry Category	Mandatory
Access	ro
PDO Mapping	No
Value Range	1 - C7h
Default Value	No

Sub-Index	1h
Description	AL 1 Alternate input value 1
Entry Category	Mandatory
Access	rw
PDO Mapping	No
Value Range	data type specific
Default Value	No

Sub-Index	2h
Description	AL 1 Alternate input value 2
Entry Category	Optional
Access	rw
PDO Mapping	No
Value Range	data type specific
Default Value	No

to

Sub-Index	C7h
Description	AL 1 Alternate input value 199
Entry Category	Optional
Access	rw
PDO Mapping	No
Value Range	data type specific
Default Value	No

7.2.109 Object 6505h: AL 1 Link alternate input

This object describes the source for the AL Input Value if it lies within another functional block of the same device. The object defined by index and sub-index is directly linked to the AL Input Value.

OBJECT DESCRIPTION

Index	6505H
Name	AL 1 Link alternate input
Object Code	RECORD
Data Type	PDOmapping
Category	Optional

ENTRY DESCRIPTION

Sub-Index	0h
Description	number of entries
Entry Category	Mandatory
Access	ro
PDO Mapping	No
Value Range	1 – C7h
Default Value	No

Sub-Index	1h
Description	AL 1 Link alternate input 1
Entry Category	Mandatory
Access	rw
PDO Mapping	No
Value Range	0 – 9h
Default Value	No

Sub-Index	2h
Description	AL 1 Link alternate input 2
Entry Category	Optional
Access	rw
PDO Mapping	No
Value Range	0 – 9h
Default Value	No

to

Sub-Index	C7h
Description	AL 1 Link alternate input 199
Entry Category	Optional
Access	rw
PDO Mapping	No
Value Range	0 – 9h
Default Value	No

7.2.110 Object 6506h: AL 1 Fault mode

A value of 0 specifies that the state of output AL 1 is not changed in case of a fault condition. If value is 1 then AL 1 Fault State is output of AL 1 state if there is a fault condition.

OBJECT DESCRIPTION

Index	6506h
Name	AL 1 Fault mode
Object Code	ARRAY
Data Type	Unsigned8
Category	Optional

ENTRY DESCRIPTION

Sub-Index	0h
Description	number of entries
Entry Category	Mandatory
Access	ro
PDO Mapping	No
Value Range	1 - C7h
Default Value	No

Sub-Index	1h
Description	AL 1 Fault mode 1
Entry Category	Mandatory
Access	rw
PDO Mapping	No
Value Range	0 – 1h
Default Value	1h

Sub-Index	2h
Description	AL 1 Fault mode 2
Entry Category	Optional
Access	rw
PDO Mapping	No
Value Range	0 – 1h
Default Value	1h

to

Sub-Index	199
Description	AL 1 Fault mode 199
Entry Category	Optional
Access	rw
PDO Mapping	No
Value Range	0 – 1h
Default Value	1h

7.2.111 Object 6507h: AL 1 Fault state

State of Alarm output, if there is a fault condition and AL 1 Fault Mode is 1.

OBJECT DESCRIPTION

Index	6507h
Name	AL 1 Fault state
Object Code	ARRAY
Data Type	Boolean
Category	Optional

ENTRY DESCRIPTION

Sub-Index	0h
Description	number of entries
Entry Category	Mandatory
Access	ro
PDO Mapping	No
Value Range	1 - C7h
Default Value	No

Sub-Index	1h
Description	AL 1 Fault state 1
Entry Category	Mandatory
Access	rw
PDO Mapping	No
Value Range	Boolean
Default Value	FALSE

Sub-Index	2h
Description	AL 1 Fault state 2
Entry Category	Optional
Access	rw
PDO Mapping	No
Value Range	Boolean
Default Value	FALSE

to

Sub-Index	C7h
Description	AL 1 Fault state 199
Entry Category	Optional
Access	rw
PDO Mapping	No
Value Range	Boolean
Default Value	FALSE

7.2.112 Object 6508h: AL 1 Type

This object specifies the alarm type.

Value	Meaning
0h	No Alarm Function
1h	Sensor Fault
2h	above or equal

Value	Meaning
3h	Below
4h	Difference (input - alternate input) above
5h	Difference below
6h	in window (including borders)
7h	out of window (excluding borders)
8h	reserved
:::	:::
11h	reserved
12h	above with starting condition
13h	below with starting condition
14h	Difference above with starting condition
15h	Difference below with starting condition
16h	in window with starting condition
17h	out of window with starting condition
18h	reserved
:::	:::
FFh	reserved

OBJECT DESCRIPTION

Index	6508h
Name	AL 1 Type
Object Code	ARRAY
Data Type	Unsigned8
Category	Optional

ENTRY DESCRIPTION

Sub-Index	0h
Description	number of entries
Entry Category	Mandatory
Access	ro
PDO Mapping	No
Value Range	1 - C7h
Default Value	No

Sub-Index	1h
Description	AL 1 Type 1
Entry Category	Mandatory
Access	rw
PDO Mapping	No
Value Range	Unsigned8
Default Value	0

Sub-Index	2h
Description	AL 1 Type 2
Entry Category	Optional
Access	rw
PDO Mapping	No
Value Range	Unsigned8
Default Value	0

to

Sub-Index	C7h
Description	AL 1 Type 199
Entry Category	Optional
Access	rw
PDO Mapping	No
Value Range	Unsigned8
Default Value	0

7.2.113 Object 6509h: AL 1 Action

This object defines which actions are performed, if the alarm state is changing.

Objects 6519h, 6529h ... 65F9h are similar defined.

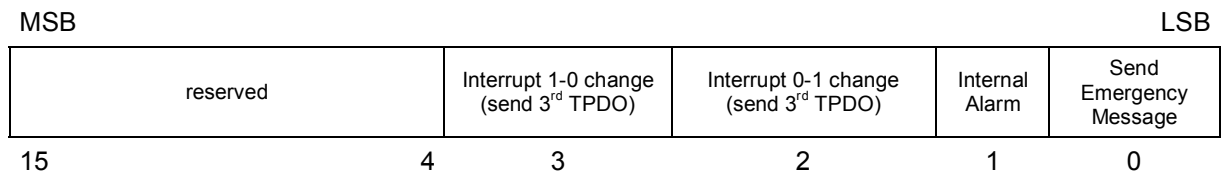

Value	Meaning
0	not valid
1	valid

OBJECT DESCRIPTION

Index	6509h
Name	AL 1 Action
Object Code	ARRAY
Data Type	Unsigned8
Category	Optional

ENTRY DESCRIPTION

Sub-Index	0h
Description	number of entries
Entry Category	Mandatory
Access	ro
PDO Mapping	No
Value Range	1 - C7h
Default Value	No

Sub-Index	1h
Description	AL 1 Action 1
Entry Category	Mandatory
Access	rw
PDO Mapping	No
Value Range	Unsigned8
Default Value	0

Sub-Index	2h
Description	AL 1 Action 2
Entry Category	Optional
Access	rw
PDO Mapping	No
Value Range	Unsigned8
Default Value	0

to

Sub-Index	C7h
Description	AL 1 Action 199
Entry Category	Optional
Access	rw
PDO Mapping	No
Value Range	Unsigned8
Default Value	0

7.2.114 Object x50Ah: AL 1 Level

This object represents the level, which the AL Input Value is compared with. It is scaled in the physical unit of process values (e.g. degrees centigrade, kg, kN, mm etc.). If alarm type is "window" then this object represents the lower limit of the window.

Objects x51Ah, x52Ah ... x5FAh are defined similar.

OBJECT DESCRIPTION

Index	x50Ah
Name	AL 1 Level
Object Code	ARRAY
Data Type	Float, Integer16, Integer24, Integer32
Category	Mandatory

ENTRY DESCRIPTION

Sub-Index	0h
Description	number of entries
Entry Category	Mandatory
Access	ro
PDO Mapping	No
Value Range	1 - C7h
Default Value	No

Sub-Index	1h
Description	AL 1 Level 1
Entry Category	Mandatory
Access	rw
PDO Mapping	No
Value Range	data type specific
Default Value	0

Sub-Index	2h
Description	AL 1 Level 2
Entry Category	Optional
Access	rw
PDO Mapping	No
Value Range	data type specific
Default Value	0

to

Sub-Index	C7h
Description	AL 1 Level 199
Entry Category	Optional
Access	rw
PDO Mapping	No
Value Range	data type specific
Default Value	0

7.2.115 Object x50Bh: AL 1 Hysteresis

This object represents the hysteresis, which is used for the comparison of AL Input Value and AL Level. It helps the AL State not to alter too fast when AL Input Values are noisy. Hysteresis is scaled in the physical unit of process values (e.g. degrees centigrade, kg, kN, mm etc.). If alarm type is "window" then this object specifies the width of the window.

Objects x51Bh, x52Bh ... x5FBh are defined similar.

OBJECT DESCRIPTION

Index	x50Bh
Name	AL 1 Hysteresis
Object Code	ARRAY
Data Type	Float, Integer16, Integer24, Integer32
Category	Optional

ENTRY DESCRIPTION

Sub-Index	0h
Description	number of entries
Entry Category	Mandatory
Access	ro
PDO Mapping	No
Value Range	1 - C7h
Default Value	No

Sub-Index	1h
Description	AL 1 Hysteresis 1
Entry Category	Mandatory
Access	rw
PDO Mapping	No
Value Range	data type specific
Default Value	1

Sub-Index	2h
Description	AL 1 Hysteresis 2
Entry Category	Optional
Access	rw
PDO Mapping	No
Value Range	data type specific
Default Value	1

to

Sub-Index	C7h
Description	AL 1 Hysteresis 199
Entry Category	Optional
Access	rw
PDO Mapping	No
Value Range	data type specific
Default Value	1

7.2.116 Object 650Ch: AL 1 Group

Alarm Outputs can be grouped together, that multiple alarms are grouped to a single AL Group State bit. A maximum of 8 groups can be defined. A value of 0 means, that the alarm state is not tied to a alarm group.

Objects 651Ch, 652Ch ... 65FCh are defined similar.

OBJECT DESCRIPTION

Index	650Ch
Name	AL 1 Group
Object Code	ARRAY
Data Type	Unsigned8
Category	Optional

ENTRY DESCRIPTION

Sub-Index	0h
Description	number of entries
Entry Category	Mandatory
Access	ro
PDO Mapping	No
Value Range	1 - C7h
Default Value	No

Sub-Index	1h
Description	AL 1 Group 1
Entry Category	Mandatory
Access	rw
PDO Mapping	No
Value Range	0 - 8
Default Value	0

Sub-Index	2h
Description	AL 1 Group 2
Entry Category	Optional
Access	rw
PDO Mapping	No
Value Range	0 - 8
Default Value	0

to

Sub-Index	C7h
Description	AL 1 Group 199
Entry Category	Optional
Access	rw
PDO Mapping	No
Value Range	0 - 8
Default Value	0

7.2.117 Object 650Dh: AL 1 State

Alarm state represents the result of the alarm comparison.

Objects 651Dh, 652Dh ... 65FDh are defined similar.

OBJECT DESCRIPTION

Index	650Dh
Name	AL 1 State
Object Code	ARRAY
Data Type	Boolean
Category	Optional

ENTRY DESCRIPTION

Sub-Index	0h
Description	number of entries
Entry Category	Mandatory
Access	ro
PDO Mapping	No
Value Range	1 - C7h
Default Value	No

Sub-Index	1h
Description	AL 1 State 1
Entry Category	Mandatory
Access	ro
PDO Mapping	Possible
Value Range	Boolean
Default Value	No

Sub-Index	2h
Description	AL 1 State 2
Entry Category	Optional
Access	ro
PDO Mapping	Possible
Value Range	Boolean
Default Value	No

to

Sub-Index	C7h
Description	AL 1 State 199
Entry Category	Optional
Access	ro
PDO Mapping	Possible
Value Range	Boolean
Default Value	No

7.2.118 Object 650Eh: AL 1 Reset

This write-only object resets the alarm function block, which is important, if hysteresis or starting conditions are defined.

Objects 651Eh, 652Eh ... 65FEh are defined similar.

OBJECT DESCRIPTION

Index	650Eh
Name	AL 1 Reset
Object Code	ARRAY
Data Type	Boolean
Category	Optional

ENTRY DESCRIPTION

Sub-Index	0h
Description	number of entries
Entry Category	Mandatory
Access	ro
PDO Mapping	No
Value Range	1 - C7h
Default Value	No

Sub-Index	1h
Description	AL 1 Reset 1
Entry Category	Mandatory
Access	wo
PDO Mapping	No
Value Range	Boolean
Default Value	No

Sub-Index	2h
Description	AL 1 Reset 2
Entry Category	Optional
Access	wo
PDO Mapping	No
Value Range	Boolean
Default Value	No

to

Sub-Index	C7h
Description	AL 1 Reset 199
Entry Category	Optional
Access	wo
PDO Mapping	No
Value Range	Boolean
Default Value	No

7.2.119 Object 6600h: AL 1..8 State

Alarm state represents the result of the alarm comparison of alarm number 1 to 8.

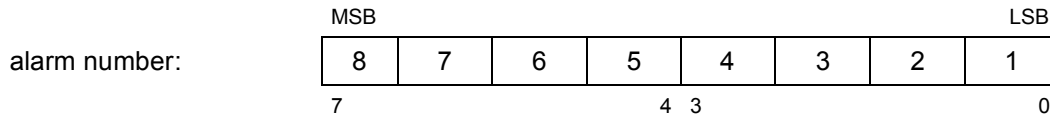

Value	Meaning
0	not occurred
1	occurred

OBJECT DESCRIPTION

Index	6600H
Name	AL 1..8 State
Object Code	ARRAY
Data Type	Unsigned8
Category	Mandatory

ENTRY DESCRIPTION

Sub-Index	0h
Description	number of entries
Entry Category	Mandatory
Access	ro
PDO Mapping	No
Value Range	1 - C7h
Default Value	No

Sub-Index	1h
Description	AL 1..8 State 1
Entry Category	Mandatory
Access	ro
PDO Mapping	Possible
Value Range	Unsigned8
Default Value	No

Sub-Index	2h
Description	AL 1..8 State 2
Entry Category	Optional
Access	ro
PDO Mapping	Possible
Value Range	Unsigned8
Default Value	No

to

Sub-Index	C7h
Description	AL 1..8 State 199
Entry Category	Optional
Access	ro
PDO Mapping	Possible
Value Range	Unsigned8
Default Value	No

7.2.120 Object 6601h: AL 9..16 State

Alarm state represents the result of the alarm comparison of alarm number 9 to 16.

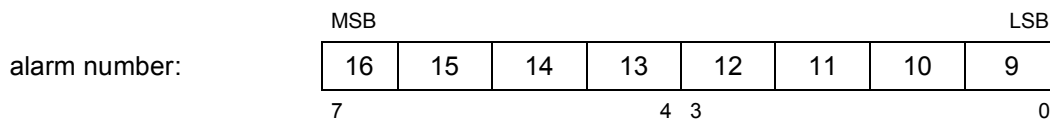

Value	Meaning
0	not occurred
1	occurred

OBJECT DESCRIPTION

Index	6601h
Name	AL 9..16 State
Object Code	ARRAY
Data Type	Unsigned8
Category	Optional

ENTRY DESCRIPTION

Sub-Index	0h
Description	Number of entries
Entry Category	Mandatory
Access	ro
PDO Mapping	No
Value Range	1 - C7h
Default Value	No

Sub-Index	1h
Description	AL 9..16 State 1
Entry Category	Mandatory
Access	ro
PDO Mapping	Possible
Value Range	Unsigned8
Default Value	No

Sub-Index	2h
Description	AL 9..16 State 2
Entry Category	Optional
Access	ro
PDO Mapping	Possible
Value Range	Unsigned8
Default Value	No

to

Sub-Index	C7h
Description	AL 9..16 State 199
Entry Category	Optional
Access	ro
PDO Mapping	Possible
Value Range	Unsigned8
Default Value	No

7.2.121 Object 6602h: AL General state

Logical OR-result of all alarm states of all alarm channels.

OBJECT DESCRIPTION

Index	6602
Name	AL General state
Object Code	VAR
Data Type	Boolean
Category	Optional

ENTRY DESCRIPTION

Access	ro
PDO Mapping	Possible
Value Range	Boolean
Default Value	No

7.2.122 Object 6603h: AL Group 1..8 State

A single bit in the group alarm state is set to one if at least one of the alarms tied to this group is true.

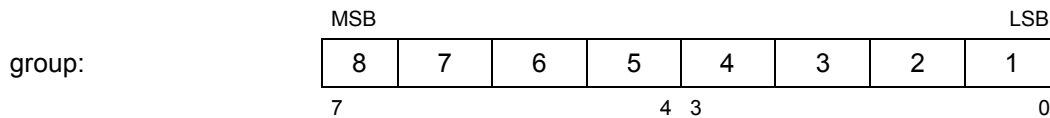

Value	Meaning
0	not occurred
1	occurred

OBJECT DESCRIPTION

Index	6603h
Name	AL Group 1..8 State
Object Code	VAR
Data Type	Unsigned8
Category	Optional

ENTRY DESCRIPTION

Access	ro
PDO Mapping	Possible
Value Range	Unsigned8
Default Value	No

7.2.123 Object 6610h: AL General Reset

This write only object resets all alarms of all channels within the unit which is important, if hysteresis or starting conditions are defined.

OBJECT DESCRIPTION

Index	6610h
Name	AL General Reset
Object Code	VAR
Data Type	Boolean
Category	Optional

OBJECT DESCRIPTION

Access	wo
PDO Mapping	Possible
Value Range	Boolean
Default Value	No

7.2.124 Object 6611h: AL 1..8 Reset

Alarm reset bits of alarm 1 to 8 grouped together within one byte.

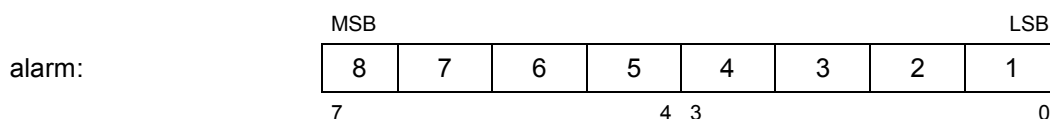

Value	Meaning
0	do not perform reset
1	perform reset

OBJECT DESCRIPTION

Index	6611h
Name	AL 1..8 Reset
Object Code	ARRAY
Data Type	Unsigned8
Category	Optional

ENTRY DESCRIPTION

Sub-Index	0h
Description	number of entries
Entry Category	Mandatory
Access	ro
PDO Mapping	No
Value Range	1 - C7h
Default Value	No

Sub-Index	1h
Description	AL 1..8 Reset 1
Entry Category	Mandatory
Access	wo
PDO Mapping	Possible
Value Range	Unsigned8
Default Value	No

Sub-Index	2h
Description	AL 1..8 Reset 2
Entry Category	Optional
Access	wo
PDO Mapping	Possible
Value Range	Unsigned8
Default Value	No

to

Sub-Index	C7h
Description	AL 1..8 Reset 199
Entry Category	Optional
Access	wo
PDO Mapping	Possible
Value Range	Unsigned8
Default Value	No

7.2.125 Object 6612h: AL 9..16 Reset

Alarm reset bits of alarm 9 to 16 grouped together within in byte.

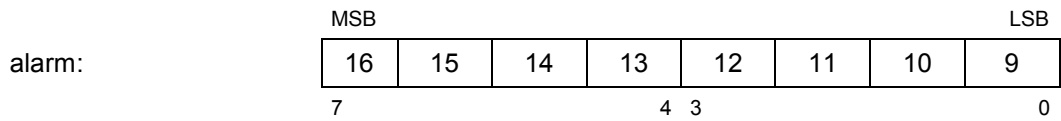

Value	Meaning
0	do not perform reset
1	perform reset

OBJECT DESCRIPTION

Index	6612h
Name	AL 9..16 Reset
Object Code	ARRAY
Data Type	Unsigned8
Category	Optional

ENTRY DESCRIPTION

Sub-Index	0h
Description	number of entries
Entry Category	Mandatory
Access	ro
PDO Mapping	No
Value Range	1 - C7h
Default Value	No

Sub-Index	1h
Description	AL 9..16 Reset 1
Entry Category	Mandatory
Access	wo
PDO Mapping	Possible
Value Range	Unsigned8
Default Value	No

Sub-Index	2h
Description	AL 9..16 Reset 2
Entry Category	Optional
Access	wo
PDO Mapping	Possible
Value Range	Unsigned8
Default Value	No

to

Sub-Index	C7h
Description	AL 9..16 Reset 199
Entry Category	Optional
Access	wo
PDO Mapping	Possible
Value Range	Unsigned8
Default Value	No

7.2.126 Object 6F20h: Life counter

The life counter is incremented in a manufacturer specific way to make sure for a receiver of PDO data that the system is still alive and is producing new values.

OBJECT DESCRIPTION

Index	6F20h
Name	Life counter
Object Code	ARRAY
Data Type	Unsigned8
Category	Optional

ENTRY DESCRIPTION

Sub-Index	0h
Description	number of valid entries
Entry Category	Mandatory
Access	ro
PDO Mapping	No
Value Range	0 - C7h
Default Value	No

Sub-Index	1h
Description	Life counter 1
Entry Category	Mandatory
Access	ro
PDO Mapping	Possible
Value Range	Unsigned8
Default Value	0

Sub-Index	2h
Description	Life counter 2
Entry Category	Optional
Access	ro
PDO Mapping	Possible
Value Range	Unsigned8
Default Value	0

to

Sub-Index	C7h
Description	Life counter 199
Entry Category	Optional
Access	ro
PDO Mapping	Possible
Value Range	Unsigned8
Default Value	0

7.2.127 Object 6F30h: Receive PDO check

This object defines check-bytes for receive PDOs 1 to n. If mapped into a receive PDO, the check-byte is copied from the receive PDO to the data object each time the PDO is received and can be evaluated by the application. The algorithm for calculating the check-byte is manufacturer specific.

OBJECT DESCRIPTION

Index	6F30h
Name	Receive PDO check
Object Code	ARRAY
Data Type	Unsigned8
Category	Optional

ENTRY DESCRIPTION

Sub-Index	0h
Description	number of valid entries
Entry Category	Mandatory
Access	ro
PDO Mapping	No
Value Range	0 – 10h
Default Value	No

Sub-Index	1h
Description	rPDO 1 Check
Entry Category	Mandatory
Access	wo
PDO Mapping	Possible
Value Range	Unsigned8
Default Value	No

Sub-Index	2h
Description	rPDO 2 Check
Entry Category	Optional
Access	wo
PDO Mapping	Possible
Value Range	Unsigned8
Default Value	No

to

Sub-Index	10h
Description	rPDO 16 Check
Entry Category	Optional
Access	wo
PDO Mapping	Possible
Value Range	Unsigned8
Default Value	No

7.2.128 Object 6F31h: Transmit PDO check

This object defines check-bytes for transmit PDOs 1 to n. If mapped into a transmit PDO, the check-byte is calculated and copied to the transmit PDO each time the PDO is transmitted. The algorithm for calculating the check-byte is manufacturer specific.

OBJECT DESCRIPTION

Index	6F30h
Name	Transmit PDO check
Object Code	ARRAY
Data Type	Unsigned8
Category	Optional

ENTRY DESCRIPTION

Sub-Index	0h
Description	number of valid entries
Entry Category	Mandatory
Access	ro
PDO Mapping	No
Value Range	0 – 10h
Default Value	No

Sub-Index	1h
Description	tPDO 1 Check
Entry Category	Mandatory
Access	ro
PDO Mapping	Possible
Value Range	Unsigned8
Default Value	No

Sub-Index	2h
Description	tPDO 2 Check
Entry Category	Optional
Access	ro
PDO Mapping	Possible
Value Range	Unsigned8
Default Value	No

to

Sub-Index	10h
Description	tPDO 16 Check
Entry Category	Optional
Access	ro
PDO Mapping	Possible
Value Range	Unsigned8
Default Value	No

7.2.129 Object xF50h: Received PV

General input process value, which is used as input for analogue output (output process value), controller (effective current value) or alarm (input value for alarm 1..16) function block depending on type of module.

OBJECT DESCRIPTION

Index	xF50h
Name	Received PV
Object Code	ARRAY
Data Type	specified by index
Category	Mandatory

ENTRY DESCRIPTION

Sub-Index	0h
Description	number of channels
Entry Category	Mandatory
Access	ro
PDO Mapping	No
Value Range	1 - C7h
Default Value	No

Sub-Index	1h
Description	Received PV 1
Entry Category	Mandatory
Access	rw
PDO Mapping	Possible
Value Range	Unsigned8
Default Value	No

Sub-Index	2h
Description	Received PV 2
Entry Category	Optional
Access	rw
PDO Mapping	Possible
Value Range	Unsigned8
Default Value	No

to

Sub-Index	C7h
Description	Received PV 199
Entry Category	Optional
Access	rw
PDO Mapping	Possible
Value Range	Unsigned8
Default Value	No

7.2.130 Object xF51h: Alternate received PV

Alternate input process value, which is used as input for alarm (alternate input value for alarm 1..16) function block.

OBJECT DESCRIPTION

Index	xF51h
Name	Alternate received PV
Object Code	ARRAY
Data Type	specified by index
Category	Optional

ENTRY DESCRIPTION

Sub-Index	0h
Description	number of channels
Entry Category	Mandatory
Access	ro
PDO Mapping	No
Value Range	1 - C7h
Default Value	No

Sub-Index	1h
Description	Alternate received PV 1
Entry Category	Mandatory
Access	rw
PDO Mapping	Possible
Value Range	Unsigned8
Default Value	No

Sub-Index	2h
Description	Alternate received PV 2
Entry Category	Optional
Access	rw
PDO Mapping	Possible
Value Range	Unsigned8
Default Value	No

to

Sub-Index	C7h
Description	Alternate received PV 199
Entry Category	Optional
Access	rw
PDO Mapping	Possible
Value Range	Unsigned8
Default Value	No

7.2.131 Object 6F52h: Received status

General input status value which is used as input for analogue output (output process value), controller (effective current value) or alarm (input value for alarm 1..16) function block depending on type of module. This status byte will make sure that input process values are only used in these functional blocks when they are valid.

OBJECT DESCRIPTION

Index	6F52h
Name	Received status
Object Code	ARRAY
Data Type	Unsigned8
Category	Mandatory

ENTRY DESCRIPTION

Sub-Index	0h
Description	number of channels
Entry Category	Mandatory
Access	ro
PDO Mapping	No
Value Range	1 - C7h
Default Value	No

Sub-Index	1h
Description	Received status 1
Entry Category	Mandatory
Access	rw
PDO Mapping	Possible
Value Range	Unsigned8
Default Value	No

Sub-Index	2h
Description	Received status 2
Entry Category	Optional
Access	rw
PDO Mapping	Possible
Value Range	Unsigned8
Default Value	No

to

Sub-Index	C7h
Description	Received status 199
Entry Category	Optional
Access	rw
PDO Mapping	Possible
Value Range	Unsigned8
Default Value	No

7.2.132 Object 6F53h: Alternate received status

General input status value, which is used as alternate input for analogue output (output process value), controller (effective current value) or alarm (input value for alarm 1..16) function block depending on type of module. This status byte will make sure that alternate input process values are only used in these functional blocks when they are valid.

OBJECT DESCRIPTION

Index	6F53h
Name	Alternate received status
Object Code	ARRAY
Data Type	Unsigned8
Category	Optional

ENTRY DESCRIPTION

Sub-Index	0h
Description	number of channels
Entry Category	Mandatory
Access	ro
PDO Mapping	No
Value Range	1 - C7h
Default Value	No

Sub-Index	1h
Description	Alternate received status 1
Entry Category	Mandatory
Access	rw
PDO Mapping	Possible
Value Range	Unsigned8
Default Value	No

Sub-Index	2h
Description	Alternate received status 2
Entry Category	Optional
Access	rw
PDO Mapping	Possible
Value Range	Unsigned8
Default Value	No

to

Sub-Index	C7h
Description	Alternate received status 199
Entry Category	Optional
Access	rw
PDO Mapping	Possible
Value Range	Unsigned8
Default Value	No

7.2.133 Object 6F60h: Transmission Enable

This object enables transmission of PDOs when a transmission event is detected. This object may be used to make sure that all receiving modules are ready within the operational state before PDOs are transmitted within the bus.

OBJECT DESCRIPTION

Index	6F60h
Name	Transmission Enable
Object Code	VAR
Data Type	Boolean
Category	Optional

ENTRY DESCRIPTION

Access	rw
PDO Mapping	No
Value Range	Boolean
Default Value	FALSE